

CITY-WIDE URBAN DESIGN GUIDELINES

VOLUME 1

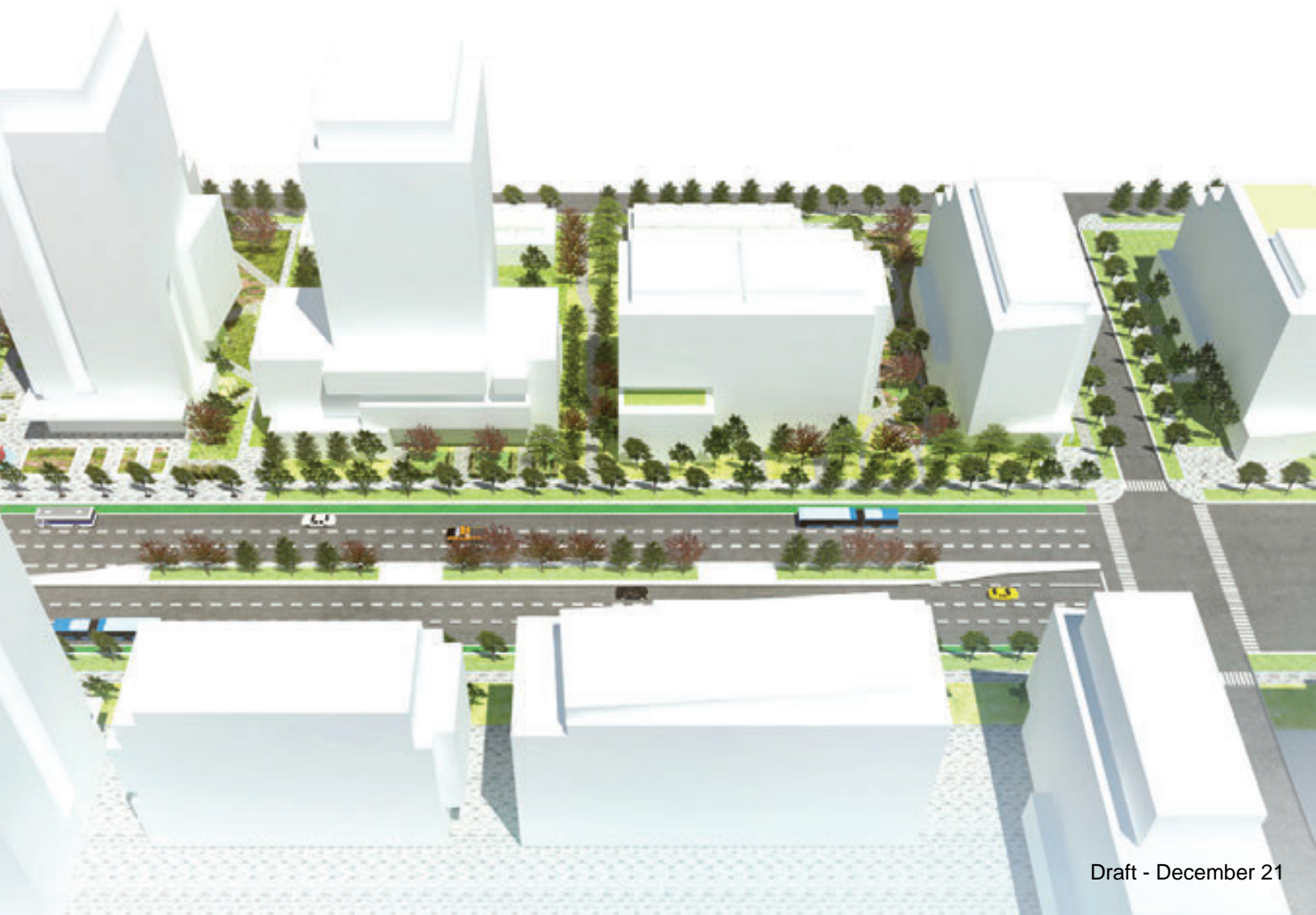

Acknowledgments:

Study Lead:

Development Planning Department - Urban Design

Technical Advisory Committee:

Policy Planning Department

Environmental Sustainability

Development Planning Department

Cultural Heritage

Development Engineering and Infrastructure Planning

Zoning Services

Transportation Services Parks And Forestry Operations

Parks and Open Space Planning

Parks Development

Consultant Team:

Brook McIlroy

Contents

| | |
|---------------------------------------|-----------|
| 01: INTRODUCTION | 1 |
| 1.1: ROLE OF THE GUIDELINES | 2 |
| 1.2: APPLICATION OF THE GUIDELINES | 3 |
| 1.3: HOW TO USE THIS DOCUMENT | 5 |
| 02: VISION & FRAMEWORKS | 11 |
| 2.1: EMERGENCE OF THE CITY OF VAUGHAN | 12 |
| 2.2: CITY STRUCTURE | 15 |
| 2.3: URBAN DESIGN VISION | 19 |
| 03: DESIGN PRIORITIES | 21 |
| 3.1: DESIGN PRIORITIES | 22 |
| 3.2: ACCESSIBILITY AND SUSTAINABILITY | 26 |
| 3.3: THE GREEN VAUGHAN APPROACH | 27 |
| 3.4: DEMONSTRATION PLANS | 30 |
| 04: SITE CONTEXT | 53 |
| 4.1: CONTEXT ANALYSIS | 54 |
| 4.2: METHODOLOGY | 54 |
| 4.3: PUBLIC REALM FRAMEWORK | 57 |
| 05: SITE AND BUILDING DESIGN | 79 |
| 5.1: INTRODUCTION | 80 |
| 5.2: SITE ORGANIZATION AND DESIGN | 80 |
| 5.3: BUILDING DESIGN | 111 |

06: LANDSCAPE TYPOLOGIES 157

| | |
|-----------------------------------|-----|
| 6.1: APPROACH TO LANDSCAPE DESIGN | 158 |
| 6.2: COMMON AMENITY SPACES | 165 |

07: BUILDING USES 177

| | |
|---|-----|
| 7.1: INTRODUCTION | 178 |
| 7.2: MIXED-USE BUILDINGS | 179 |
| 7.3: MULTI-FAMILY RESIDENTIAL BUILDINGS | 181 |
| 7.4: COMMERCIAL BUILDINGS | 185 |
| 7.3: COMMUNITY FACILITIES | 193 |
| 7.3: EMPLOYMENT BUILDINGS | 197 |

08: PHASING

09: CHECKLIST (TO COME)

APPENDIX A: GLOSSARY

Performance Standards

04: SITE CONTEXT 53

| | |
|--|-----------|
| 4.3 Public Realm Framework | 57 |
| 4.3.1 Streets and Blocks | 58 |
| 4.3.2 Lot Sizes and Variety | 61 |
| 4.3.3 Landmarks and Views | 63 |
| 4.3.4 Development Adjacent to Trails | 64 |
| 4.3.5 Development Adjacent to Natural Heritage | 65 |
| 4.3.6 Development Adjacent to Agriculture | 69 |
| 4.3.7 Development Adjacent to Cultural Heritage | 71 |
| 4.3.8 Development Adjacent to Open Space | 75 |
| 4.3.9 Development Adjacent to Employment and/or Highways | 77 |

05: SITE AND BUILDING DESIGN 79

| | |
|--|-----------|
| 5.2 Site Organization & Design | 81 |
| 5.2.1 Building Location and Orientation | 81 |
| 5.2.2 Micro-Climate and Sky View | 83 |
| 5.2.3 Surface Parking | 87 |
| 5.2.4 Below-Grade Parking | 91 |
| 5.2.5 Above-Grade Structured Parking | 92 |
| 5.2.6 Servicing, Storage Areas and Loading | 93 |
| 5.2.7 Private Roads | 95 |
| 5.2.8 Driveways and Laneways | 97 |
| 5.2.9 Grading and Drainage | 99 |
| 5.2.10 Screening, Fencing and Low Walls | 100 |
| 5.2.11 Mid-Block Connections/Mews | 101 |
| 5.2.12 Pedestrian and Cycling Connections and Street Furnishings | 103 |

| | |
|--|------------|
| 5.2.13 Site Signage and Wayfinding | 105 |
| 5.2.14 Public Art | 107 |
| 5.2.15 Site Lighting | 109 |
| 5.2.16 Utilities | 110 |
| 5.3 Building Design | 111 |
| 5.3.1 Buildings on Intensification Corridors | 111 |
| 5.3.2 High-Rise Building Envelope | 115 |
| 5.3.3 Mid-Rise Building Envelope | 120 |
| 5.3.4 Low-Rise Building Envelope | 126 |
| 5.3.5 Townhouse Design | 128 |
| 5.3.6 Built Form Transitions | 133 |
| 5.3.7 Separation Distances | 136 |
| 5.3.8 Thresholds and Entrances | 139 |
| 5.3.9 Facade Design and Materials | 149 |
| 5.3.10 Roof Design | 151 |
| 5.3.11 Building Signage | 152 |
| 5.3.12 Building Lighting | 153 |
| 5.3.13 Bird Friendly Design | 154 |
| 5.3.14 Building Elements | 155 |

06: LANDSCAPE TYPOLOGIES 157

| | |
|---|------------|
| 6.1 Approach to Landscape Design | 158 |
| 6.1.1 The Green Approach | 159 |
| 6.1.2 The Green Approach On Intensification Corridors | 162 |
| 6.2 Common Amenity Spaces | 165 |
| 6.2.1 General Guidelines for Common Amenity Space | 165 |
| 6.2.2 Private Grade-Related Amenity Spaces + Courtyards | 166 |
| 6.2.3 Rooftop Amenity Spaces | 167 |
| 6.2.4 Internalized Courtyards | 169 |
| 6.2.5 Urban Squares | 170 |
| 6.2.6 Gardens | 172 |
| 6.2.7 Publicly Accessible Interiors | 173 |
| 6.2.8 Privately Owned Publicly-Accessible Spaces (POPS) | 175 |

07: BUILDING USES 177

| | |
|---|------------|
| 7.2 Mixed-Use Buildings | 179 |
| 7.2.1 Mixed-Use Buildings | 179 |
| 7.3 Multi-Family Residential Buildings | 181 |
| 7.3.1 Apartment Buildings | 181 |
| 7.3.2 Townhouses | 183 |
| 7.4 Commercial Buildings | 185 |
| 7.4.1 General Guidelines for Commercial Buildings | 185 |
| 7.4.2 Urban Format Retail | 187 |
| 7.4.3 Gas Stations | 189 |
| 7.4.4 Drive-Through | 191 |
| 7.5 Community Facilities | 193 |
| 7.5.1 General Guidelines for Community Facilities | 193 |
| 7.6 Employment Buildings | 197 |
| 7.6.1 General Guidelines for Employment Buildings | 197 |
| 7.6.2 Prestige Employment Buildings | 199 |
| 7.6.3 Internally Oriented Office Uses | 200 |
| 7.6.4 Employment/Industrial Buildings | 201 |

Section 1: **INTRODUCTION**

1.1

Role of the Guidelines

The City of Vaughan’s Urban Design Guidelines provide performance based directions for building and site design. Urban Design Guidelines establish a consistent level of design excellence for new intensification and infill development throughout the City. To reflect the significant wealth of natural heritage and green space in the City, an approach to extending green networks has been developed to direct the character of the City’s streets, public spaces and communities.

The City of Vaughan (“the City” or “Vaughan”) is a dynamic and growing municipality in the heart of the Greater Golden Horseshoe (GGH) region. Its strong economic growth, built and cultural heritage, natural heritage and hydrological features, access to regional destinations and investment in transit all enhance its appeal as a place to live and work. These investments in transit and civic infrastructure are also attracting significant new development to the City.

The City-Wide Urban Design Performance Standards have been prepared to articulate objectives for placemaking and high quality urban design throughout Vaughan, to help realize the vision in the City of Vaughan Official Plan (Vaughan OP).

The Guidelines provide design objectives and Performance Standards for building, landscape and site design that seek to create places for people through well-scaled, well-landscaped and context-driven development along the City’s streets, open spaces and Natural Heritage Network. The intent is that these Performance Standards will provide a clear and common set of expectations about how buildings should be developed for City Staff, the public, and members of the development community, including architects and landscape architects.

1.2

Application of the Guidelines

The City Wide Urban Design Guidelines provide guidance for most building types and they apply throughout the City.

The City-Wide Urban Design Guidelines apply to all building types, except single detached, semi-detached, duplex and triplex forms of housing. The Guidelines apply throughout the City, and complement the Vaughan Metropolitan Centre and other areas which have their own set of comprehensive urban design guidelines or Heritage Conservation District plans. Their use will focus, however, on the City's Intensification Areas, infill in community areas and employment areas (see Urban Structure Map on the opposite page), which are areas of the City where varying change is anticipated.

The Urban Design Guidelines complement and support the City's existing policies and guidelines, including the following:

- City of Vaughan Official Plan (2010)
- Urban Design Guidelines for Infill Development in Established Low-Rise Residential Neighbourhoods (2016)
- Heritage Conservation District Plans and Guidelines for Thornhill, Kleinburg-Nashville, Woodbridge and Maple

- Secondary Plans, Area-Specific Plans and Site-Specific Plans and Guidelines
- Sustainability Performance Metrics
- City-Wide Streetscape Implementation Manual and Financial Strategy (2014)
- City-Wide Public Art Program (2016)

Where a conflict exists, the direction contained in the Official Plan, Heritage Conservation District Plans and Secondary, Area or Site-Specific Plans will prevail over the City-Wide Urban Design Guidelines except in special cases where the City may give preference to the City-Wide Urban Design Guidelines.

In Intensification Areas and Heritage Conservation Districts, the City-Wide Streetscape Implementation Manual should be referred to for boulevard details and level of service requirements to complement the building and site design guidance contained in the Urban Design Guidelines.

It is expected that these Guidelines will inform the City's update to the City-wide Zoning By-Law, planned for 2017 - 2019.

CITY OF VAUGHAN URBAN STRUCTURE MAP (OFFICIAL PLAN SCHEDULE 1, 2010)

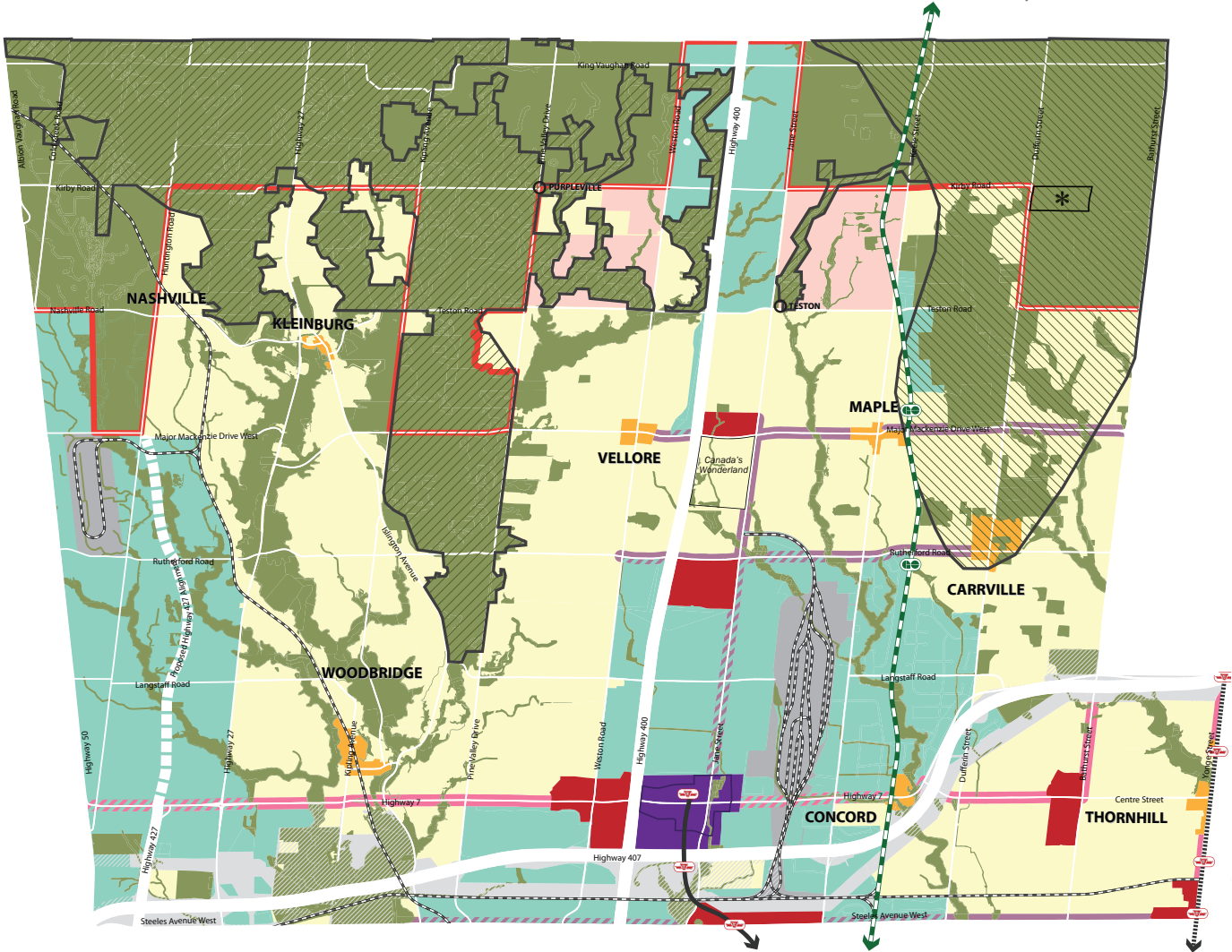

- Urban Boundary
 - Urban Growth Centre Boundary
- Stable Areas**
- Natural Areas and Countryside
 - Community Areas
 - New Community Areas
 - Employment Areas
 - Rail Facilities
- Intensification Areas**
- Vaughan Metropolitan Centre (Regional Centre)
 - Primary Centres
 - Local Centres
 - Regional Intensification Corridors
 - Regional Intensification Corridors within Employment Areas
 - Primary Intensification Corridors
 - Primary Intensification Corridors within Employment Areas
- Parkway Belt West Lands
 - Railway
 - Subway Extension
 - Proposed Subway Extension
 - GO Transit Network
 - Greenbelt Plan Area¹
 - Oak Ridges Moraine Conservation Plan Area¹
 - Urban Growth Centre Boundary
 - O Hamlet
 - See Minister's Decision on ORMCP Designation
 - Municipal Boundary

¹ See Schedule 4 for limits and land use information of the Greenbelt Plan Area and Oak Ridges Moraine Conservation Plan Area

1.3

How to Use this Document

The Urban Design Guidelines provide Performance Standards for building, landscape and site design. They are accompanied by an online Technical Reference Manual (Volume 2).

1.3.1

City-Wide Urban Design Guidelines

The City-Wide Urban Design Guidelines provide Performance Standards for a range of building typologies, as well as key site, landscape, building design, and public realm elements. This document should be referred to when designing any type of building in Vaughan, with the exception of sites in the Vaughan Metropolitan Centre and other areas with their own set of Urban Design Guidelines or Heritage Conservation District Plans. This document should, however, be used to supplement information that may be missing from existing Urban Design Guidelines, as per the City of Vaughan's discretion.

The document is organized as a series of Performance Standards. Each Performance Standard contains an overall objective, along with detailed guidance to assist designers in achieving that objective. It is intended that creativity and sensitivity to context should be encouraged to achieve the intent of each Performance Standard, with consideration of alternative approaches on a case-by-case basis where it can be demonstrated that the objective is being met.

Please refer to the diagram on the following page for guidance on how to navigate the guidelines.

1.3.2

Technical Reference Manual

The Urban Design Guidelines are supported by an online Reference Manual that contains relevant design details, guidelines and Terms of Reference for reports and studies that are required as part of a complete development application. This Manual includes:

1. Terms of Reference for Wind Studies
2. Terms of Reference for Sun/Shadow Studies
3. Urban Design Tree Replacement Requirements
4. Bird Safe Design Guidelines
5. Woodland Edge Management Plan Terms of Reference
6. Sustainability Performance Metrics
7. Engineering Design Criteria
8. City-Wide Streetscape Implementation Manual
9. Terms of Reference for Urban Design Briefs
10. Urban Design Detail Library
11. Tree Protection Protocol

This technical reference manual is subject to change over time.

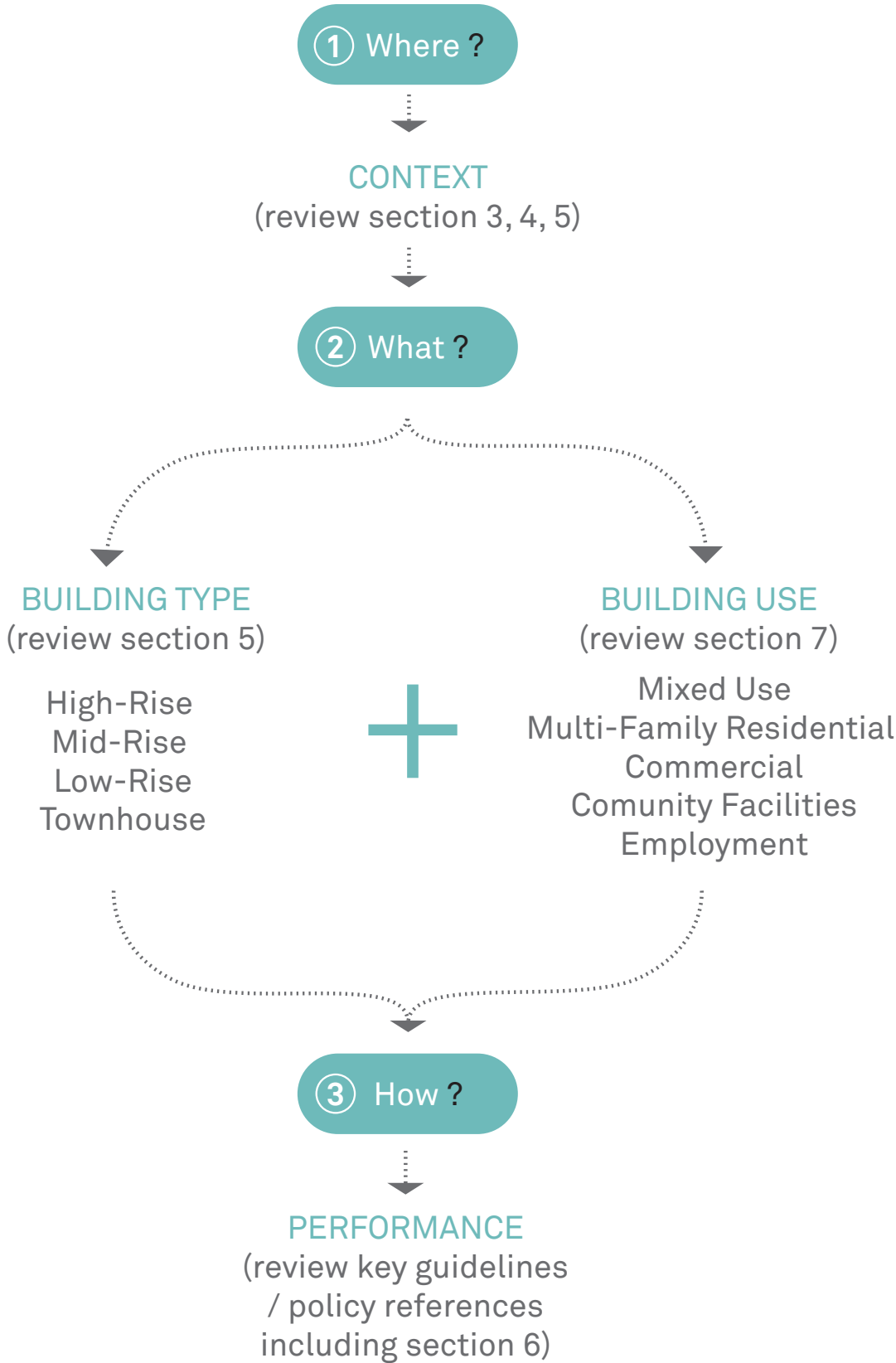

1.3.3

Approvals Process

Throughout the approvals process, each development will be reviewed by the City and relevant agencies (such as TRCA or York Region), per the complete application submission requirements. It is important that the appropriate Performance Standards are adhered to at each stage in the process but also that the required Performance Standards match the required detail of the submission type. As a project moves through the approvals process from Official Plan Amendment to Building Permit, the project becomes more detailed and resolved. To respond to the evolution of a project through the approvals process, the appropriate Performance Standards will be identified at the pre-consultation meeting prior to the preparation of the submission material. Applicants should arrive at pre-consultation meetings prepared with a list of appropriate Performance Standards. The appropriate Performance Standards will need to be met at each stage of planning approval. Conformance needs to be demonstrated through the Urban Design Brief. In some cases, it may be necessary to demonstrate an ability to meet a standard during the next phase of approval but the designer and owners will have flexibility in the timing of how they meet that more detailed standard at the next phase of approval (e.g. necessary block width and depth, landscape open spaces requirements, front yard setback, etc). The general approach to applying the standards at each submission stage is outlined in the following paragraphs.

Official Plan Amendment

If you are applying for an Official Plan Amendment (OPA), you should adhere to the following:

- Pre-application consultation (PAC) meeting is

required to discuss applicable Performance Standards (focusing on appropriate Site Context and Building Typologies).

- Context Analysis, as described in Section 4.2.1, is required to demonstrate understanding of existing site context (demonstrating adherence to 4.2.1 Context Mapping).
- An Urban Design Brief is required for OPAs containing an overall Site Plan or Master Plan to demonstrate the vision and an ability to meet the appropriate Performance Standards (as identified at the Pre-Consultation Meeting).
- Deviations from the applicable Standards are to be summarized with justification within the Urban Design Brief. Acceptance of these deviations is at the discretion of the City.
- All other required materials for a complete application.

Zoning By-Law Amendment

If you are applying for a Zoning By-Law Amendment (ZBA), you should adhere to the following:

- Pre-application consultation meeting is required to discuss applicable Standards (focusing on appropriate Landscape Typologies as well as Site and Building Performance Standards. If an OPA preceded the ZBA, Site Context and Building Typology Standards do not need to be addressed again).
- Context Analysis is required to demonstrate understanding of existing site context (demonstrating adherence to 4.2.1 Context Mapping).
- An Urban Design Brief is required for ZBAs including an overall Site Plan or Master Plan to outline conformance to the Performance Standards (as

identified at the Pre-Consultation Meeting).

- Deviations from the applicable Standards are to be summarized with justification in the Urban Design Brief. Acceptance of these deviations is at the discretion of the City.
- All other required materials for a complete application.

Draft Plan of Subdivision

If you are applying for a Draft Plan of Subdivision, you should adhere to the following:

- Pre-application consultation meeting required to discuss applicable Objectives (focusing on appropriate Site Context and Building Typologies).
- Context Analysis is required to demonstrate understanding of existing site context (demonstrating adherence to 4.2.1 Context Mapping).
- An Urban Design Brief is required with an overall Site Master Plan to demonstrate an ability to achieve the Performance Standards (as identified at the Pre-Consultation Meeting).
- Deviations from the applicable Standards are to be summarized with justification in the Urban Design Brief. Acceptance of these deviations is at the discretion of the City.
- All other required materials for a complete application.

Site Plan Approval

If you are applying for a Site Plan Approval, you should adhere to the following:

- Pre-application consultation meeting required to discuss applicable Standards (focusing on appropriate Landscape Typologies as well as Site

and Building Performance Standards if the Site Context and Building Typologies Standards were addressed during the OPA Stage).

- Context Analysis is required to demonstrate understanding of existing site context (demonstrating adherence to 4.2.1 Context Mapping).
- Application of the Standards will be outlined in an Urban Design Brief if not addressed during previous approval phases. Urban Design Briefs should demonstrate how the City's design priorities and vision have been considered. If previously submitted during other stages, the Urban Design Brief should be updated for Site Plan Approval.
- Deviations from the applicable Standards are to be summarized with justification and to be included in the Urban Design Brief if not addressed during previous approval phases. Acceptance of these deviations is at the discretion of the City.
- All other required materials for a complete application.

The content of the Urban Design Brief should reflect the current project stage (refer to Section 4 for more detail). A level of corresponding detail is required as appropriate in the Urban Design Brief. Each stage of the development will require increasingly detailed resolution of the design parameters. The high level visioning stages (such as Approvals for Plan of Subdivision or OPAs) will respond primarily to the Site Design Performance Standards and will clearly identify the relevant built form objectives that will be addressed at the detailed visioning stage. The relevant standards should be confirmed through a pre-consultation meeting.

1.3.4 Role of the Urban Design Brief

Urban Design Briefs should demonstrate how the City's design priorities and vision have been considered. The Brief should describe in detail how building and site design elements meet the intent of relevant Performance Standards in the Urban Design Guidelines as well as other relevant City of Vaughan planning policies. It should mention Landscape Master Plans, Architectural Control/Design Guidelines, and Performance Standards (i.e. sustainability metrics).

1.3.5 Varying Scales of Design

Development in Vaughan occurs at a variety of scales. These scales include single lot design, consolidated lot design and large site development. The projects will also occur in both infill and greenfield conditions. To best respond to the variety of potential projects, the pre-application consultation meeting will also ensure that the level of effort required by the owner/developer team matches the scope and scale of the proposed development.

1.3.6 Reading a Performance Standard

Each Performance Standard is made of four elements. These elements include the Objective; the Mandatory Standards (as per policies and the zoning bylaw); the Directional Standards to achieve the Objective; and, the supporting images and/or directional diagrams. These elements are intended to be read together but depending on the type of approval being sought the Urban Design Brief may be required to focus on certain elements of each standard. This will be determined at the pre-consultation meeting.

Performance Standard No. 5.3.10 Roof Design

Objective

Roof design should reduce the visual impact of mechanical equipment, provide usable space on the roof where appropriate and have a positive environmental impact.

Mandatory and Directional Standards

- a. Rooftop mechanical equipment should be screened from view from public spaces using complementary building materials, parapets or other architectural devices, or by stepping the equipment back from the main building face below a minimum of 3 metres.
- b. Mechanical penthouses may be wrapped with residential units and amenity spaces.
- c. Rooftop decorative lighting is discouraged.
- d. Flat roofs and terraces are encouraged to be used as private outdoor or common amenity space for multi-unit residential buildings.
- e. Green roofs are strongly encouraged on all building types, covering roof areas not occupied by mechanical equipment.
- f. Green roofs may be combined with accessible amenity spaces.
- g. Where green roofs are not used, cool roof surfaces with a solar reflective index of 78 or higher for low-sloped roofs and 29 or higher for steep roofs should be used for all areas not occupied by mechanical equipment.
- h. Consider the use of rooftops for food production.

Supporting Image/
Directional Diagram



Well-screened rooftop mechanical equipment (Image: Dockside Green, Perkins+Will Architects)

Policy References &
Related Guidelines

Key guidelines:

- Performance Standard 5.2.2 Micro-Climate and Sky View
- Performance Standard 6.2.3 Rooftop Amenity Spaces

Section 2: **VISION & FRAMEWORKS**

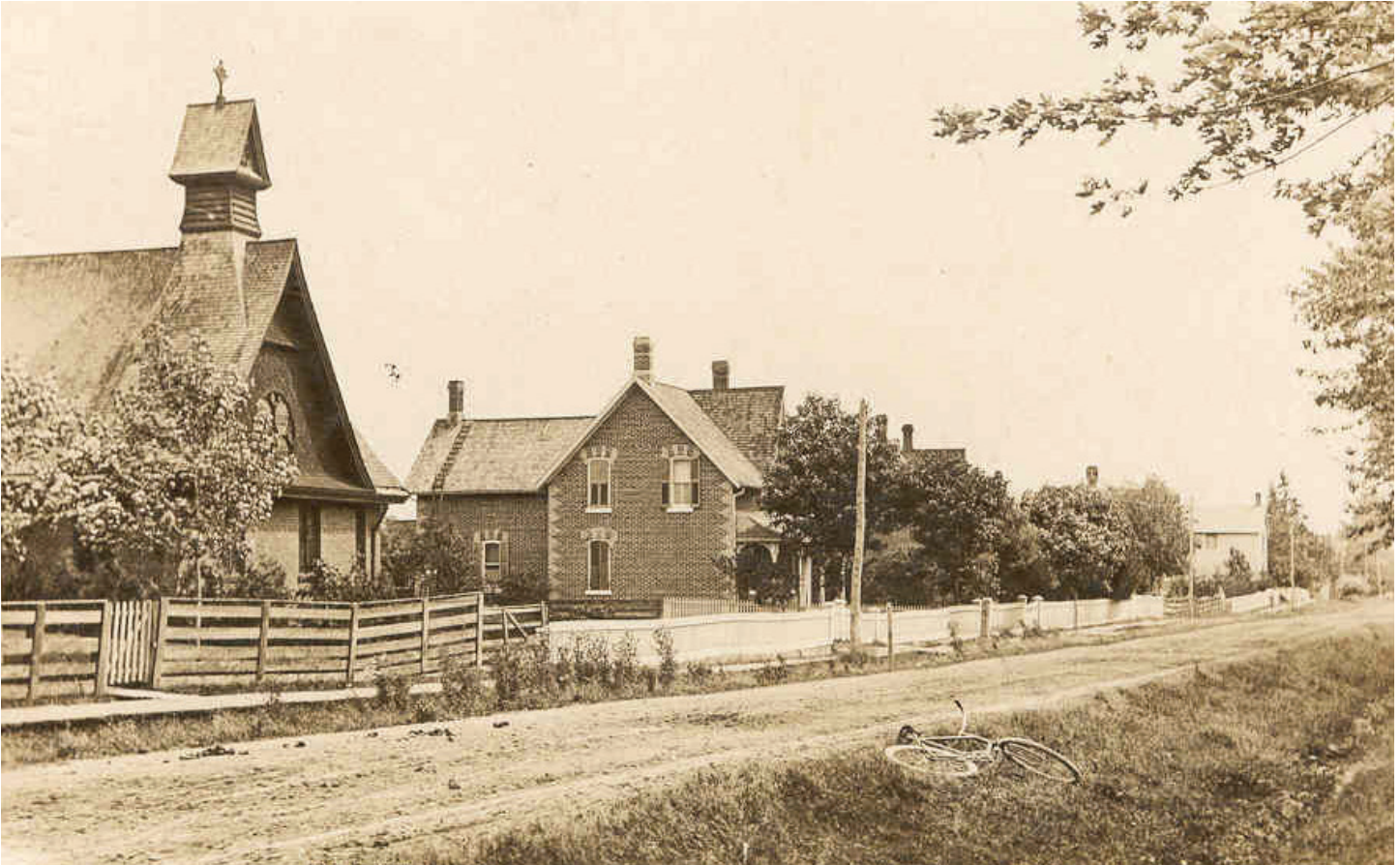

Keele Street looking south in Maple, 1909 (Image: City of Vaughan Archives, archeion.ca)

2.1 The Emergence of the City of Vaughan

Vaughan is a young and evolving City, with roots in natural landscapes and historic settlements that can still be seen in the urban fabric today.

The City of Vaughan emerged around several historic settlements to become an incorporated Town in 1974. At the time, the Town was still relatively rural in character with a population of roughly 15,000. Over the 1970s, expansion of water and sewer services transformed this rural municipality into one of the most rapidly growing municipalities in Canada. In 1991,

the Town became a City with over 100,000 people, and it is projected to keep growing to a population of 416,600 people and 266,100 jobs by 2031.

Today's Vaughan reflects its foundational elements - including the historical settlements, Concession Blocks, countryside areas and natural networks of valleys, rivers and woodlands. However, the City itself is still very young and very much in evolution.

The original grid of concession blocks that shaped



Map of Vaughan Township, 1878 (Image: Miles & Co.; McGill University Digital Collection)

early Vaughan still exists, though the roads have been widened over time. They can still be recognized as some of the most significant and well-traveled urban corridors that run through the City. This network of roads is framed by large lots and concentrations of employment uses, while the spaces between these major roads are the fine-grained neighbourhoods and open spaces that most residents of Vaughan call home.

The result of this history is a city that requires a unique approach to infill, and redevelopment that takes advantage of the natural assets and history of urban development which still shape the City today. The structuring elements of natural networks,

historical settlements, regional corridors and employment nodes are reflected in the City's planned Urban Structure, which focuses on protecting natural areas while directing jobs and urban intensification to Employment Areas, arterial corridors and historic and emerging Centres.

The City is also bisected by Highway 400, running north-south. To the west of the highway, the City contains significant natural heritage and countryside lands, while to the east are most of the City's Centres and Intensification Corridors.

Understanding these core structuring elements has given shape to the Urban Design Guidelines within this document resulting in urban design direction for

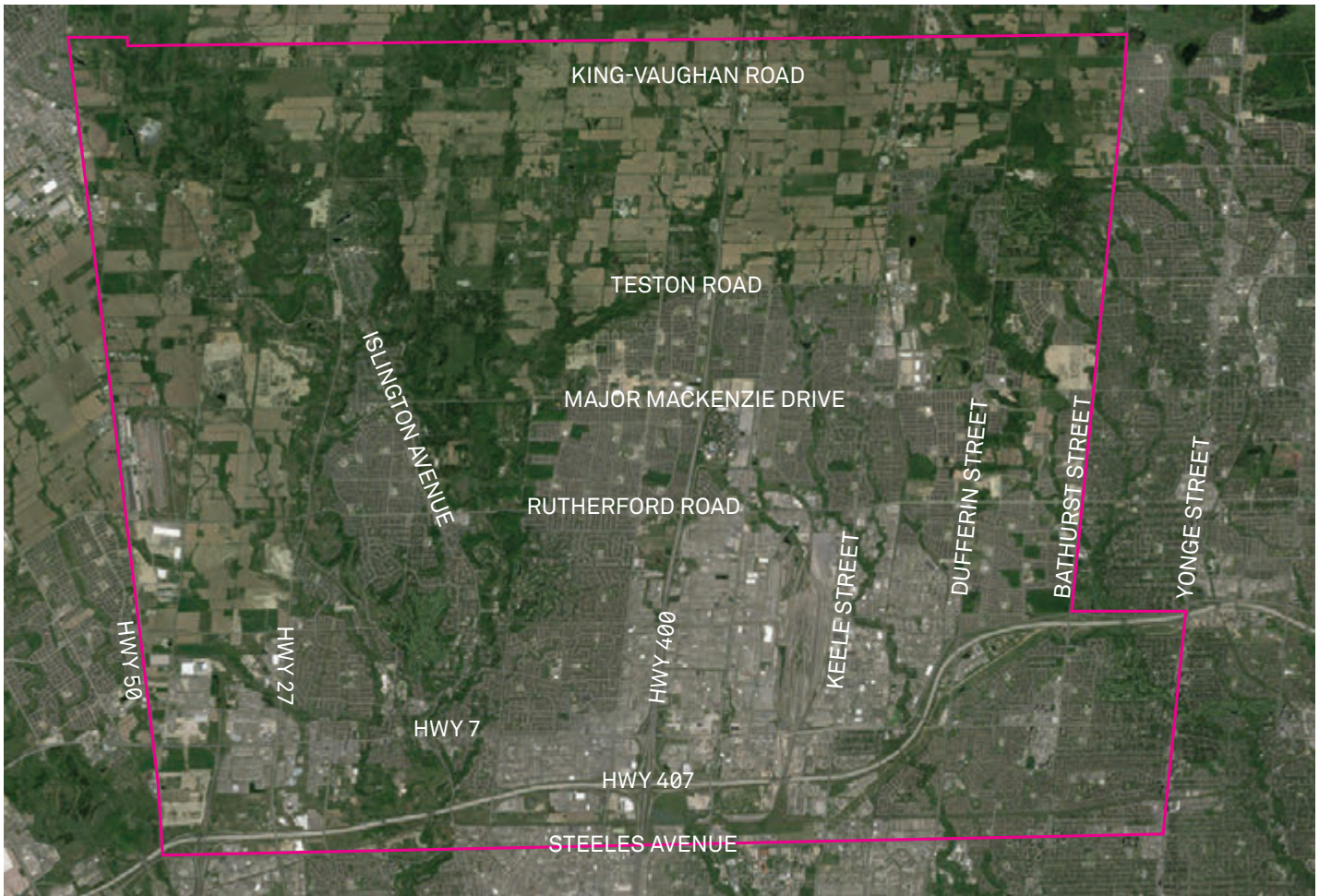

Aerial image of the City of Vaughan, 2016 (Image: Google Earth)

new development that will strengthen the existing character and identity of Vaughan.

While these structuring frameworks themselves are well-established, the Urban Design Guidelines focus on articulating the elements of their design that are required to build community, create healthy and sustainable neighbourhoods and establish places for people. These recommendations address the City's buildings, landscapes and public spaces to provide a holistic vision for the future evolution of the City's urban fabric.

The vision for each of these core elements is described further in the following sections.

2.2 City Structure

2.2.1 A Green City Approach

The City of Vaughan is made up of almost 40% natural areas and countryside, including watercourses, woodlands (11.3%), forest cover (16%), wetlands (1.5%), greenbelt protection (38%) related open spaces, agricultural lands and a system of multi-use trails that connects many of these areas. Vaughan is home to the headwaters of the Humber and the Don Rivers and also contains parts of the Greenbelt and the Oak Ridges Moraine. Conceptually, the focus on knitting these natural areas together with a network of green streets is Vaughan's "Green Approach" to urban redevelopment.

These networks provide the foundation for development within the City, contributing to a high quality of life by ensuring easy access to natural amenities. They also play a key role in food production, maintaining healthy ecosystems and habitats, and mitigating climate change.

The City's Official Plan speaks to the importance of these systems, through **Goal 2: A Robust and Prominent Countryside** and **Goal 7: A Green and Sustainable City**. Policy 3.2.3.1 states Council's intention to "protect and enhance the Natural Heritage Network as an interconnected system of natural features and the functions they perform". New development can support the Official Plan's goals and policy objectives by strengthening and extending natural systems through careful site and building design. This also includes effective transitions and buffers, sustainable building design and a strategic approach to on-site landscape, tree planting and stormwater management.

2.2.2 Historic Settlement Nodes

The historic settlements of Woodbridge, Kleinburg/Nashville, Maple and Thornhill, along with other small settlements, remain central to Vaughan's neighbourhood development. Though their unique character is enhanced through specific Heritage Conservation District Plans and accompanying guidelines, these settlements are also identified as Local Centres and/or are located along Intensification Corridors. This means that although their historic character and heritage resources will be protected and maintained, new development should be in keeping with the local context.

In the City's Official Plan, **Goal 1: Strong and Diverse Communities** speaks to the need to maintain the unique qualities that make these communities special, while encouraging new development that contributes to healthy, vibrant and complete communities.

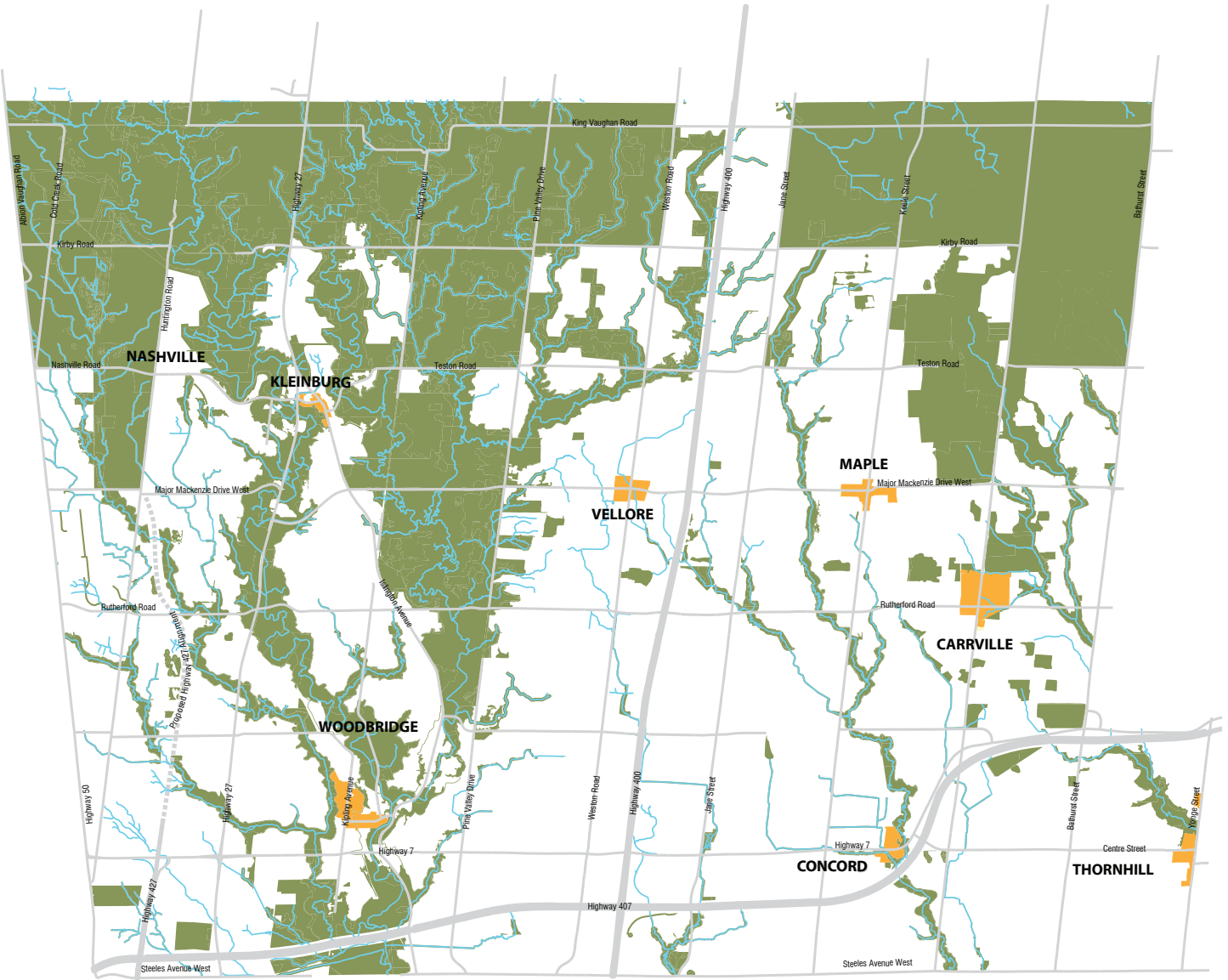

City Structure Diagram 1: Green City Approach and Historic Settlement Nodes
(Layers extracted from VOP Schedule 1)

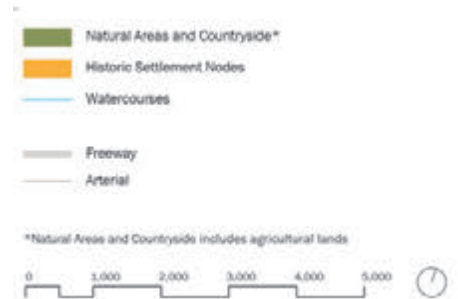

2.2.3 Regional Corridors

The City of Vaughan is crosscut by Regional Corridors that are envisioned to accommodate the majority of new transit infrastructure, connecting Vaughan residents to the rest of the Region. These Regional Corridors align with the City's Planning Framework for Intensification Corridors. **Goal 5** of the Official Plan, **Moving Around Without a Car**, reaffirms the need for multi-modal streets that will support the City's aim of achieving a City-wide modal split of 30% transit use by 2031.

To support this transit infrastructure, strategic intensification is critical, as confirmed by **Goal 8** of the Official Plan, **Directing Growth to Appropriate Locations**. Through the Official Plan, the City's Regional Corridors have been identified as preferred growth areas. The Corridors contain a diverse range of blocks and lots, many of which are significant in size. Key opportunities for new development along these Regional Corridors include the intensification of residential and employment populations through transit-oriented development forms, along with the creation of more walkable blocks and street networks.

A typical Region ROW accommodates many elements such as hydro poles, underground and above ground utilities, street trees, cycle tracks, sidewalks, coupled with massive roadways/transit ways. To recognize the transportation challenges of these corridors, this document has developed an approach that looks to urbanize the edges of Regional roads in a manner that allows them to continue to serve their regional functions.

2.2.4 Employment Nodes

The City of Vaughan has been successful in attracting significant employment growth over the past few decades, and intends to ensure that a 20-year supply of land is available to accommodate a growth forecast of 266,100 jobs by 2031. The City is fortunate in that it contains a significant amount of contiguous Employment Areas that accommodate industrial, manufacturing, warehouse and office uses in a central location with easy access to the rest of the Greater Toronto and Hamilton Area. Elsewhere, throughout the City's Intensification Corridors and Centres, retail and office growth in the form of mixed-use development is also encouraged.

Goal 3 of the Official Plan, **A Diverse Economy**, speaks to the desire to build on the City's extraordinary growth in industrial and employment uses, as well as increasing the diversity of jobs available and the location of office uses throughout the City.

Within Employment Areas, new development should support the creation of healthy, bikeable and walkable environments that improve quality of life for employees, as well as connections to adjacent natural heritage systems.

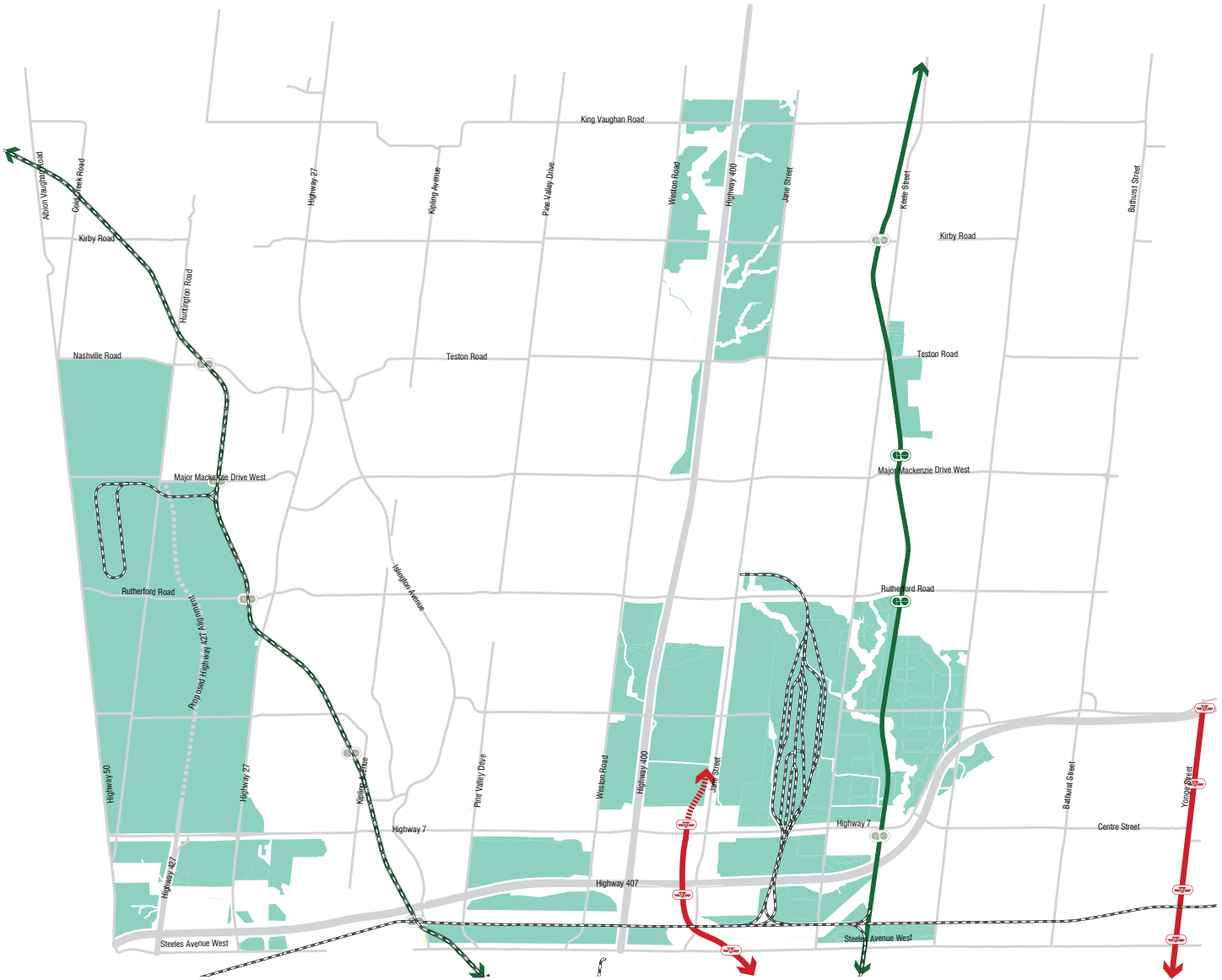

City Structure Diagram 2: Regional Corridors and Employment Areas (Nodes)
 (Layers extracted from VOP Schedule 1)

- Existing Commuter Rail Line
- Proposed Commuter Rail Line
- Existing GO Station
- Proposed GO Station
- Subway Extension
- Conceptual Subway Extension
- Subway Station
- Freeway
- Arterial
- Employment Areas



2.3 Urban Design Vision

The City-Wide Guidelines are founded on a vision to promote a consistent level of high quality urban design standards that builds on the City's core structuring elements of natural open spaces and neighbourhoods, establishes a recognizable character for the City's built environment, and enhances the pedestrian experience.



Vaughan's network of natural open spaces should be extended throughout the city through high quality landscaped setbacks. Rendering by Brook McIlroy.

Development in the City of Vaughan will be guided by the following principles:

1. Reflect Vaughan's unique context by promoting a green City development approach and contextual analysis that responds to sense of place
2. Promote Mid-Rise development as the 'missing middle' to connect nodes including historic settlement areas and employment areas
3. Encourage creativity and variety through context specific guidelines that respond to adjacent land uses, built form conditions and natural and cultural heritage
4. Frame and activate the public realm
5. Create a balance between built form and open space
6. Address interim development and changing conditions
7. Promote active transportation and healthy environments



(Image Credit: Brook McIlroy)



(Image Credit: Brook McIlroy)

Section 3: **DESIGN PRIORITIES**

3.1

Design Priorities

Building on the City of Vaughan’s unique urban and natural frameworks, the City-Wide Urban Design Guidelines are intended to create consistent, high quality development across the City that reflects local context.

The following Design Priorities provide direction for the Performance Standards contained in this document. The Urban Design Guidelines encourage creative approaches to achieving these Design Priorities. They provide detailed guidance, but also permit designers to exercise a range of creative solutions that meet the intent of the guidelines and ultimately achieve these Design Priorities and Objectives.



Boyd Conservation Area (Image Credit: TRCA)



(Image Credit: Brook McIlroy)

Priority 1

Enhance and Protect Vaughan's Natural Heritage Network

New developments will support the Natural Heritage Network by providing appropriate naturalized transitions to adjacent Natural Heritage Features. Connections to the Natural Heritage Network will be enhanced by extending tree canopies that provide ecological services, enhancing trail systems, and creating wildlife eco-passages. Where appropriate, visual and physical connections to the Natural Heritage Network (such as public access blocks, single loaded roads) will be provided. Climate change will be mitigated through sustainable building design, treatment of building setbacks with Low Impact Development techniques, and the provision of mid-block connections and associated amenities.

Priority 2

Respond to Site Context

New developments will prioritize compatibility with surrounding context, including streetscapes, built development, topography and natural heritage systems. Response to site context should complement design excellence with appropriate setbacks, massing, transitions, orientation and connections. Consideration should also be given for the future area context if the site is located in an area of transition.



Clarendon Market Commons (Image Credit: Brook McIlroy)



Canary District Condominiums and Townhomes (Image Credit: OAA. Photo by Tom Arban)

Priority 3

A Well Scaled City as a Liveable Environment for People

The scale of new development will support usable and comfortable public spaces and streets, and a range of housing and employment options. In particular, Mid-Rise building typologies will provide intensification and appropriate transitions between existing neighbourhoods and high-rise building sites to protect access to sunlight, views and privacy. The building envelopes that are encouraged in this document will support human-scaled design and enhanced pedestrian activity at the street level.

Priority 4

A Well-Connected Network that is Safe, Comfortable and Accessible

Development sites will offer permeability and connectivity to surrounding streets, sidewalks, bike lanes, trails and open spaces. This network of connections will be designed to provide safety and visibility, prioritize active modes of movement and provide access to sunlight and generous landscape, particularly for pedestrians and cyclists.



KPMG Tower, Vaughan Metropolitan Centre. (Image Credit: Diamond Schmitt Architects)



(Image Credit: Brook McIlroy)

Priority 5

Promote High Quality Architecture

New buildings will incorporate variety and visual interest, use high quality materials, demonstrate innovation and best practices in sustainability, and reflect architectural design excellence to contribute to Vaughan's reputation as an emerging leader in design.

Priority 6

Frame an Active Public Realm and Pedestrian Environment

New buildings will be designed to integrate with public spaces, amenity spaces and streetscapes. The design of sites and the ground floor of buildings will be particularly important in creating a seamless transition between private and public space and supporting a vibrant public realm.



Accessibility and sustainability should be fundamental priorities through all building and site design in the City of Vaughan. (Image Credit: Prince Arthur's Landing, Brook McIlroy)

3.2 Accessibility and Sustainability

Throughout Vaughan, new buildings and sites should promote accessibility and sustainability as overarching priorities.

The Performance Standards contained in this document are founded on the principle of promoting accessibility for all and sustainability through new urban development.

Designing for accessibility should reference both the Ontario Building Code and the Accessibility for Ontarians with Disabilities Act, including the Design of Public Spaces Standard.

Designing for sustainability should reference best practices in building, site and landscape design,

as well as the City of Vaughan's [Sustainability Performance Metrics](#) program.

The Sustainability Metrics program was developed by the Municipalities of Brampton, Vaughan and Richmond Hill to help guide, inform and rank the performance and sustainability of proposed new development.

These metrics are meant to:

- Level the playing field across the three municipalities;
- Provide consistency in submission quality;
- Simplify the submission process for applicants and reduce review time for municipal staff;
- Provide a tool to quantify and rank the intended performance of the proposed project/plan; and
- Inform the appropriate incentive for aspirational projects (and potential mandatory targets in the future).

3.3

The Green Vaughan Approach (Green Approach)

The Green Approach is a new way of thinking about how future buildings address the street and how the spaces in front of buildings work together to create a varied and vibrant urban character for the City. The Green Approach combines landscape and building performance standards to support urban variety, sustainable landscapes and design excellence in Vaughan.

A core element of the Green Approach is the City-wide standards for landscape design within enhanced front yard setbacks. Designers are recommended to include elements such as storm water features, tree planting, naturalized boulevards, and bird- and pollinator-friendly gardens between a building and street. The approach takes advantage of available space to provide a range of landscape benefits.



Bioswale in Portland, Oregon. (Image Credit: Nevue Ngan Associates)

These include generous soil volumes for mature tree growth to help achieve York Region's tree canopy target of 25-35%, Low Impact Development (LID), measures to manage stormwater at source and additional landscape to provide a wide range of ecological services. At the same time, this approach creates a network of pedestrian-focused streets that will connect the City's natural heritage systems, parks, and open spaces, while enhancing the image of Vaughan as a Green City.

To balance the enhanced landscape standards, a series of architectural performance standards have been developed to allow for design diversity and provide flexibility in the massing of the building envelope. These standards encourage buildings to have a varied façade design that responds to the program of the building and encourages active at-grade uses. The overall architectural goal of the Green Approach is to create buildings that have inherently strong relationships between the base of a building and their surroundings.

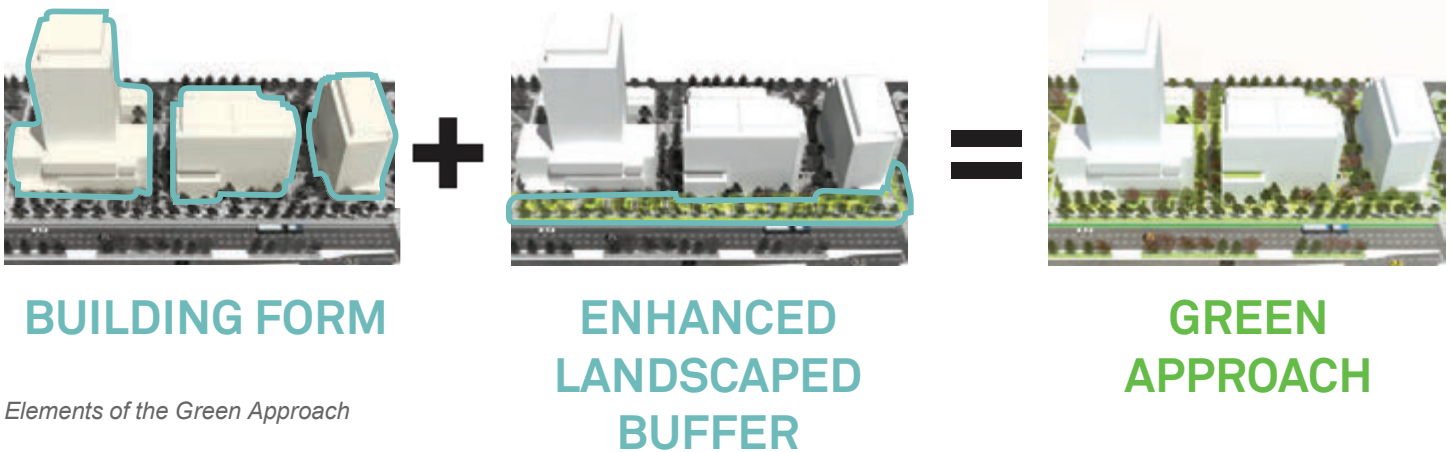

Together, the landscape and architectural approaches outlined in this document reinforce Vaughan's identity as a Green City and weaves the natural fabric into future redevelopment sites. The combined landscape and architectural vision are what is called in this document Vaughan's Green Approach.

Performance Standards for landscape and building design to achieve the Green Approach are integrated throughout the document, but are the focus of Performance Standards 5.3.1, 6.1.1 and 6.1.2. While high quality landscape design is recommended throughout development sites, the Green Approach focuses on the creation of green street edges.



Rendering of the enhanced landscape front setback. It is framed by active uses as part of Vaughan's Green Approach.

3.4 Demonstration Plans

This section contains a series of demonstration plans that articulate the vision outlined in this document. With each demonstration is also a summary of the key design elements that support the design goals and principles of this document.

The demonstration plans show general site conditions, adjacencies and key considerations that are found in existing conditions throughout the City. The five demonstration plans include:

1. A Mid- and Low-Rise, mixed-use development adjacent to an existing park and school.
2. A phased Mid-Rise redevelopment of a retail centre adjacent to an existing Low-Rise residential neighbourhood.
3. A tall, mixed-use employment and residential

development with High-Rise adjacent to an existing Low-Rise residential neighbourhood.

4. An employment building (prestige industrial or industrial) accessed off a regional road and backing onto a natural heritage area or 400 series highway.
5. A mixed unit type townhouse development with strong natural heritage links and a new urban park.

Each demonstration plan is followed by a description of how the demonstration plan meets the design priorities outlined in this urban design document. It is anticipated that future development applications requiring Urban Design Briefs will need to demonstrate how they achieve these same priorities.

Demonstration Plan #1 Phased Intensification of a Retail Site with Mid-Rise Development

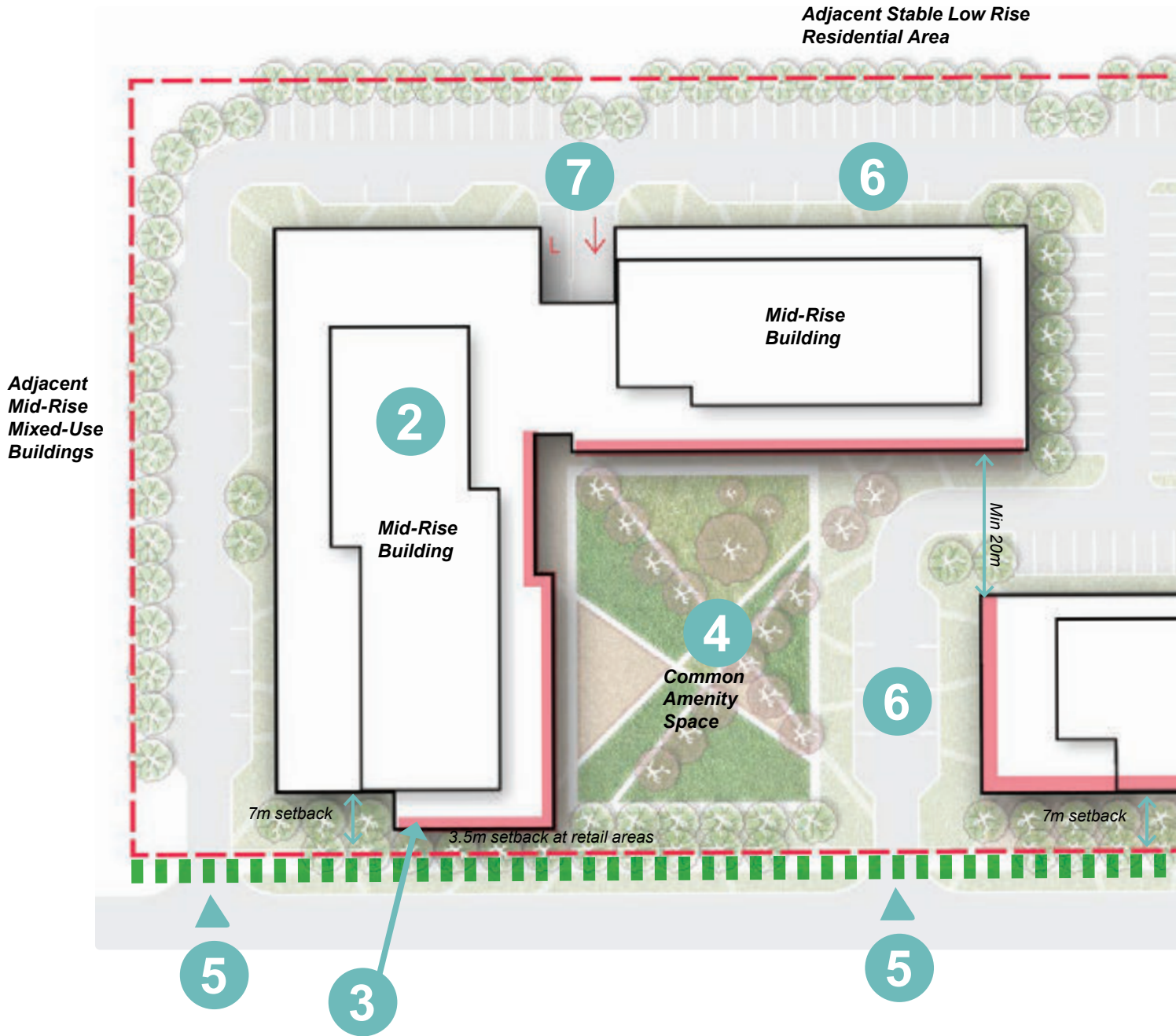

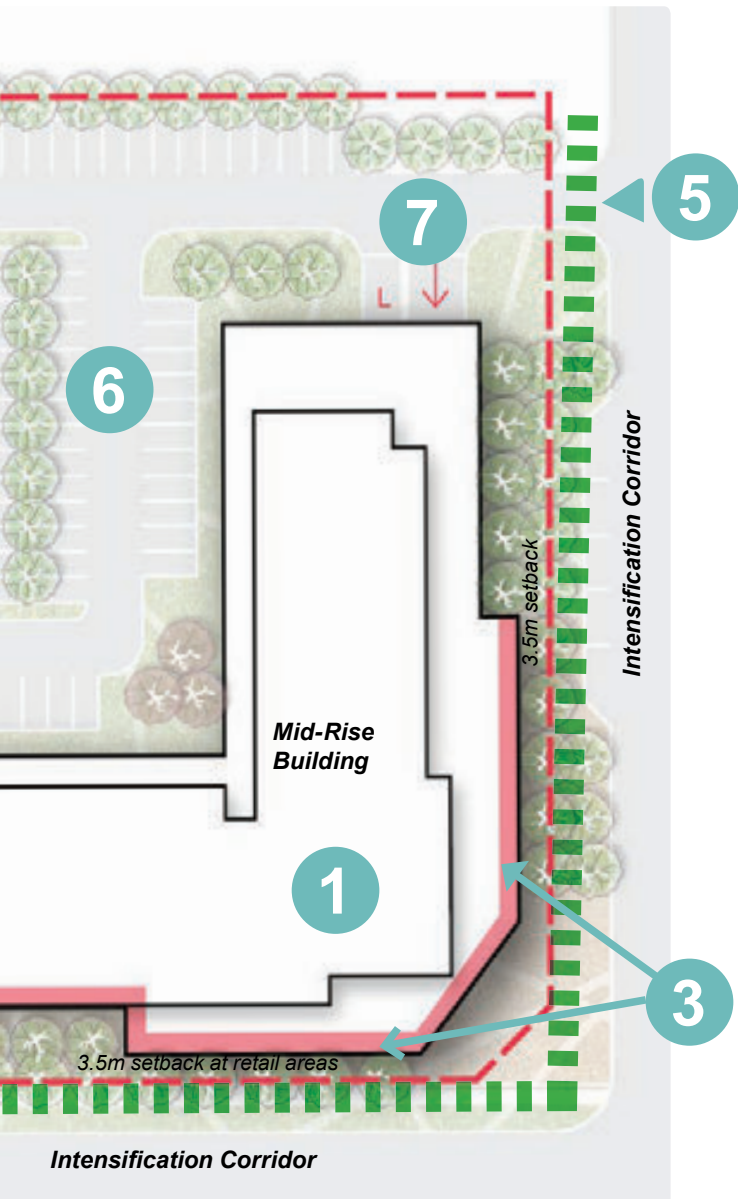

Design Principles:

- 1 Phase 1 Project - new Mid-Rise residential above retail
- 2 Phase 2 Project - new Mid-Rise residential above retail
- 3 Bring retail frontages closer to the street and the corner maintain a widened open space area with a double row of trees within the Green Approach Zone (highlighted with a dashed green line)
- 4 In Phase 2, as surface parking transitions to structured below grade parking, replace existing parking with a new central plaza framed by retail on three sides
- 5 Existing site access point is maintained and a new access point is added from the side street. (New site access can not be provided off of a Regional Road).
- 6 The at-grade surface parking has been reorganized into a series of parking courts with tree planting and sidewalks. The courts provide convenient short term parking and draw activity into the site
- 7 Minimize vehicular traffic through the site by locating servicing and loading in close proximity to entrance roads.

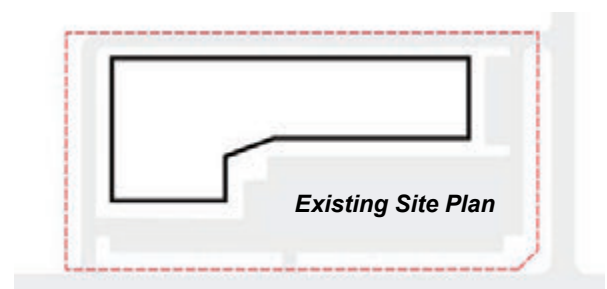

Urban Design Approach for Demonstration #1

Phased Intensification of a Retail Site with Mid-Rise Development

| <i>Design Priorities (from Section 3.1)</i> | <i>Approach to Meeting the Design Priority</i> |
|--|---|
| Priority 1 - Enhance and Protect Vaughan's Natural Heritage Network | <p>This hypothetical site is not located in proximity to an existing natural heritage network or open space (in an urban design brief, this would be demonstrated through the Context Plan (Section 4.2.1)).</p> <p>In this case the focus on meeting this design priority is on climate change mitigation and introducing L.I.D. techniques in the front yard setbacks and open space designs.</p> |
| Priority 2 - Respond to Site Context | <p>There are a number of site criteria that have shaped this demonstration design. These include:</p> <ul style="list-style-type: none"> • The site is located at the intersection of two intensification corridors so an expanded front yard setback of 7m is being used to establish a double row of continuous trees along the street as well as L.I.D. Opportunities. • At-grade retail uses encroach up to 50% along the building length. As an active use at grade those retail uses and the podium above them are permitted to encroach up to 50% into the 7m front yard setback. • Through the location of parking below grade, a new semi public open space is provided to animate the retail edges and provide social outdoor space for the development. |
| Priority 3 - A Well Scaled City as a Liveable Environment for People | <p>There are a number of key rules that have informed the type, massing and organization of the buildings. These include:</p> <ul style="list-style-type: none"> • The upper parts of the mid-rise buildings are setback from the adjacent residential areas and street to maintain an appropriately scaled development (maintaining a 45 degree angular plane to the rear of the property). • An appropriate building and human scale is provided by stepping back the upper floors of the development. This is not required in all locations but in this hypothetical scenario the setbacks have been included to respond to the existing heights and massing of the adjacent properties (not shown). As part of a development application it would be required to review adjacent properties to determine if they are likely to redevelop in the future. |

Priority 4 - A Well-Connected Network that is Safe, Comfortable and Accessible

The organization of the site looks to achieve a well-connected site design by:

- Transitioning the project into two well-scaled buildings that frame a semi-public open space.
- Connecting the semi-public open space to the adjacent streets through clearly defined walking paths and pedestrian crossings.
- Planning separate below grade parking garages for each building to allow for undisturbed soil in the open space. This contributes to long term mature tree growth.
- Orienting the buildings in such a way that promotes clear views through the site and towards the building entrances.

Priority 5 - Promote High Quality Architecture

Many elements of High Quality Design are articulated in the Site Plan Approval and Zoning By-Law Amendment stages. These criteria will include meeting the performance standards and guidelines in sections:

- 5.3.1 Buildings on Intensification Corridors
- 5.3.3 Mid-Rise Building Envelope
- 5.3.6 Built Form Transitions
- 5.3.8 Thresholds and Entrances
- 5.3.9 Facade Design and Materials
- 6.2.5 Urban Squares
- 6.1.2 The Green Approach on Intensification Corridors

Priority 6 - Frame an Active Public Realm and Pedestrian Environment

To achieve this Design Priority new buildings will be designed to integrate with public spaces, amenity spaces and streetscapes. The design of the site and the ground floor of buildings is welcoming to the public with retail wrapping the buildings at grade. This creates a seamless transition between private and public spaces and supports a vibrant public realm.

Demonstration Plan #2 Mid and Low-Rise Development Adjacent to A Park or School Site

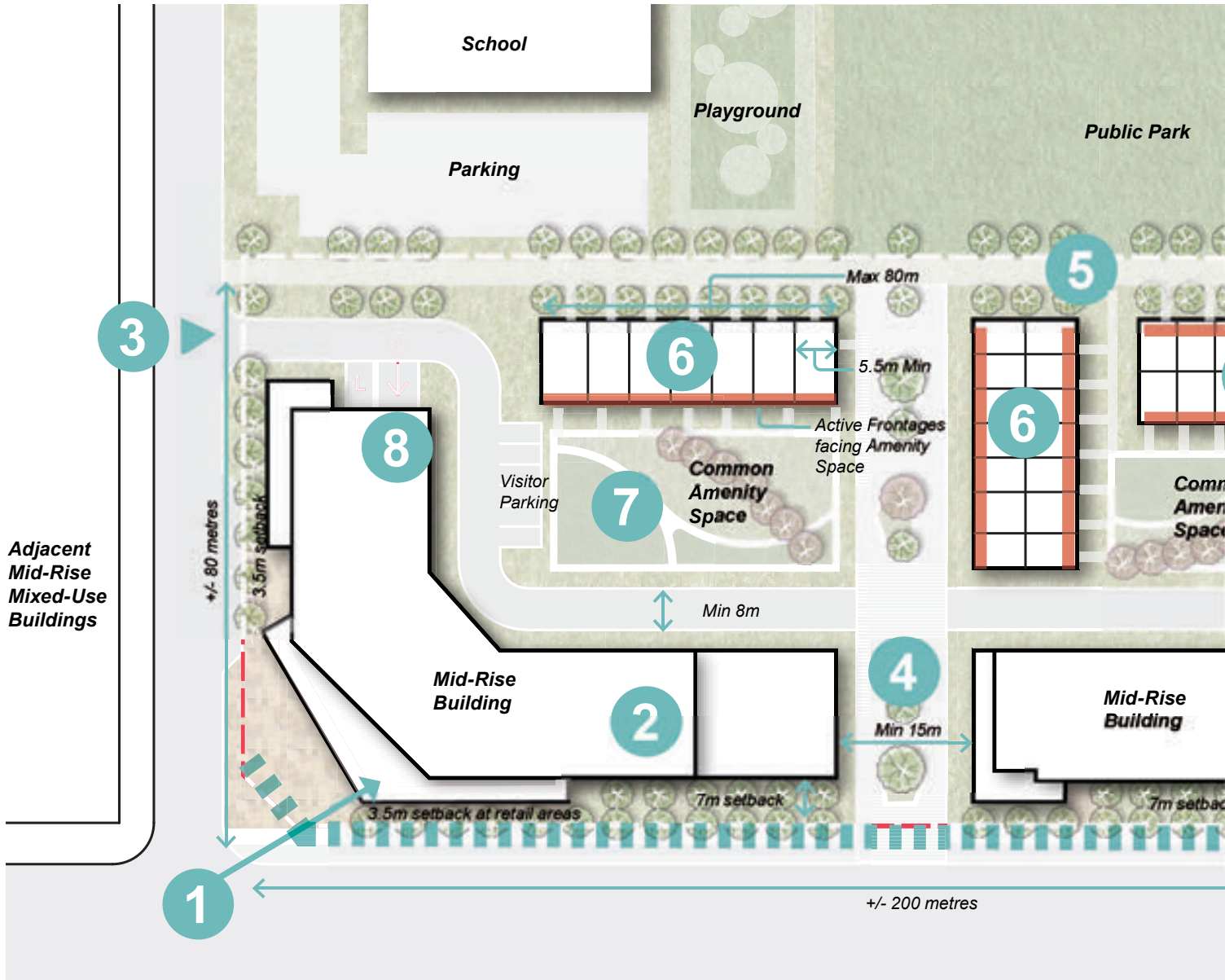

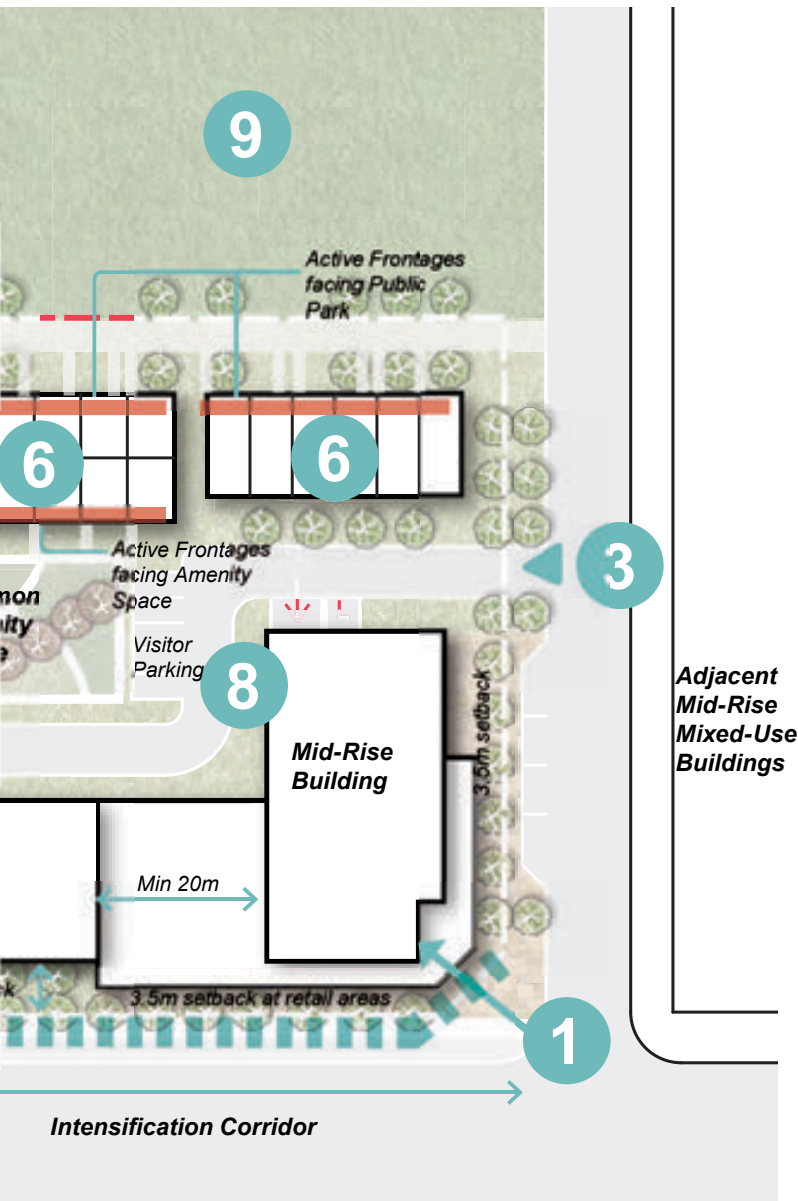

Design Principles:

- 1 Retail and commercial uses at the corner. Retail uses can encroach on the Green Approach Zone (highlighted with a dashed green line)
- 2 Mid-Rise Buildings frame the Regional Road / Intensification Corridor
- 3 Vehicular and Servicing Access drives are located along the minor streets
- 4 A 15m minimum mid-block connection is provided to break up the long block and connect the Regional Road to the parks and school to the north
- 5 Grade related uses are located along the park / tree-lined pathway
- 6 Low-Rise development is located along the northern edge of the site to transition to the sensitive uses to the north (within a 45° angular plane)
- 7 Low-Rise building frontages are oriented to activate open spaces. Back to back formats are used in areas where a double sided front is required. Primary facades are indicated with a solid orange line
- 8 Minimize vehicular traffic through the site by locating servicing and loading in close proximity to entrance roads.
- 9 Provide public access easements if the park is privately owned.

Urban Design Approach for Demonstration Plan #2 Mid-Rise Development Adjacent to A Park or School Site

| <i>Design Priorities (from Section 3.1)</i> | <i>Approach to Meeting the Design Priority</i> |
|--|---|
| Priority 1 - Enhance and Protect Vaughan's Natural Heritage Network | <p>This hypothetical site is not located in proximity to an existing natural heritage network but it is directly adjacent to a public park (in an urban design brief this would be originally identified through the Context Plan (Section 4.2.1)). Future development is required to have a positive interface with the open space. In this case there are new residential units facing the park with a new multi-use trail. There is also a focus on climate change mitigation through the introduction of L.I.D. techniques in the front yard setbacks and open space designs.</p> |
| Priority 2 - Respond to Site Context | <p>There are a number of site criteria that have shaped this demonstration design. These include:</p> <ul style="list-style-type: none"> • The site fronts onto an intensification corridor, so an expanded front yard setback of 7m is being used to establish a double row of continuous trees along the street as well as L.I.D. Opportunities. • At-grade retail uses encroach up to 50% along the building length. As an active use at grade, those retail uses and the podium above them are permitted to encroach up to 50% into the 7m front yard setback. • Through the location of parking below grade, two new semi public open space are provided to animate the central courtyards. |
| Priority 3 - A Well Scaled City as a Liveable Environment for People | <p>There are a number of key rules that have informed the type, massing and organization of the buildings. These include:</p> <ul style="list-style-type: none"> • The upper parts of the Mid-Rise buildings are set back from the adjacent school and park to minimize shadow impacts. • A transitional massing (townhouses) has been introduced to mitigate the change in height. • An appropriate building and human scale is provided by locating the massing of the Mid-Rise buildings directly adjacent to the intensification corridor and flanking streets. This creates well framed streets with strong urban edges. |

Priority 4 - A Well-Connected Network that is Safe, Comfortable and Accessible

The organization of the site looks to achieve a well-connected site design by:

- Providing a new mid-block connection to connect the site to the park and multi-use trail to the north.
- Internal walking trails within the site make the area easily navigated by foot and by bike.
- Loading, servicing and parking garage entrance are located at the entrance to the site to reduce the overall number of vehicles.
- Well-placed, easy to see visitor parking draws some cars into the site and encourages overall site activity and eyes on the street. Visitor parking can also be provided along the internal streets with the provision of a minimum 8m pavement width.
- Orienting the buildings in such a way that promotes clear views through the site and towards building entrances.

Priority 5 - Promote High Quality Architecture

Many elements of High Quality Design are articulated in the Site Plan Approval and Zoning By-Law Amendment stages. These criteria will include meeting the performance standards and guidelines in sections:

- 5.3.1 Buildings on Intensification Corridors
- 5.3.3 Mid-Rise Building Envelope
- 5.3.6 Built Form Transitions
- 5.3.8 Thresholds and Entrances
- 5.3.9 Facade Design and Materials
- 6.2.5 Urban Squares
- 6.1.2 The Green Approach on Intensification Corridors

Priority 6 - Frame an Active Public Realm and Pedestrian Environment

To achieve this Design Priority, new buildings will be designed to integrate with public spaces, amenity spaces and streetscapes. The design of the site and the ground floor of buildings should be welcoming to the public with retail wrapping the buildings at grade. This creates a seamless transition between private and public spaces and supports a vibrant public realm.

Demonstration Plan #3 High and Mid-Rise, Mixed-Use Development with Employment and Residential

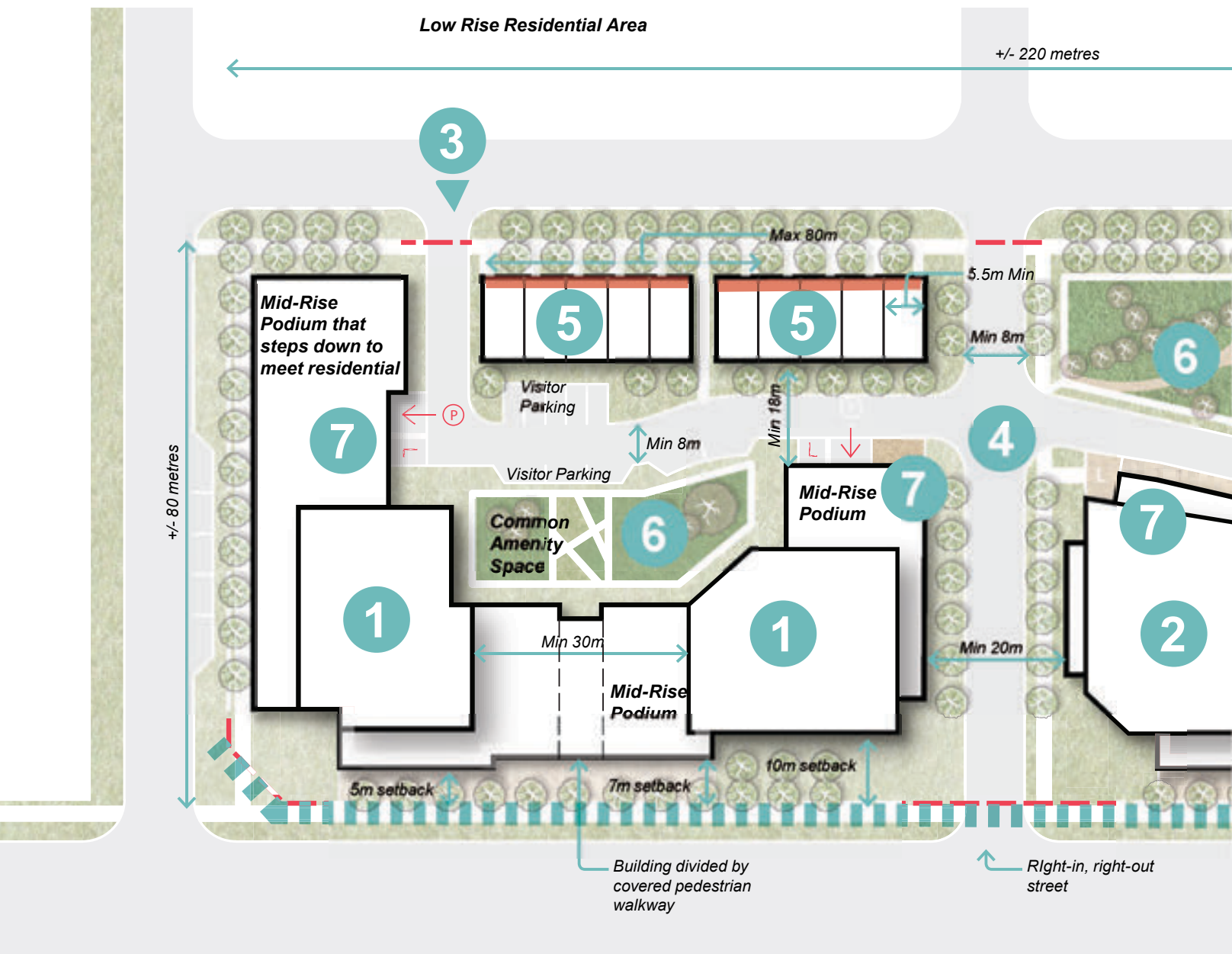

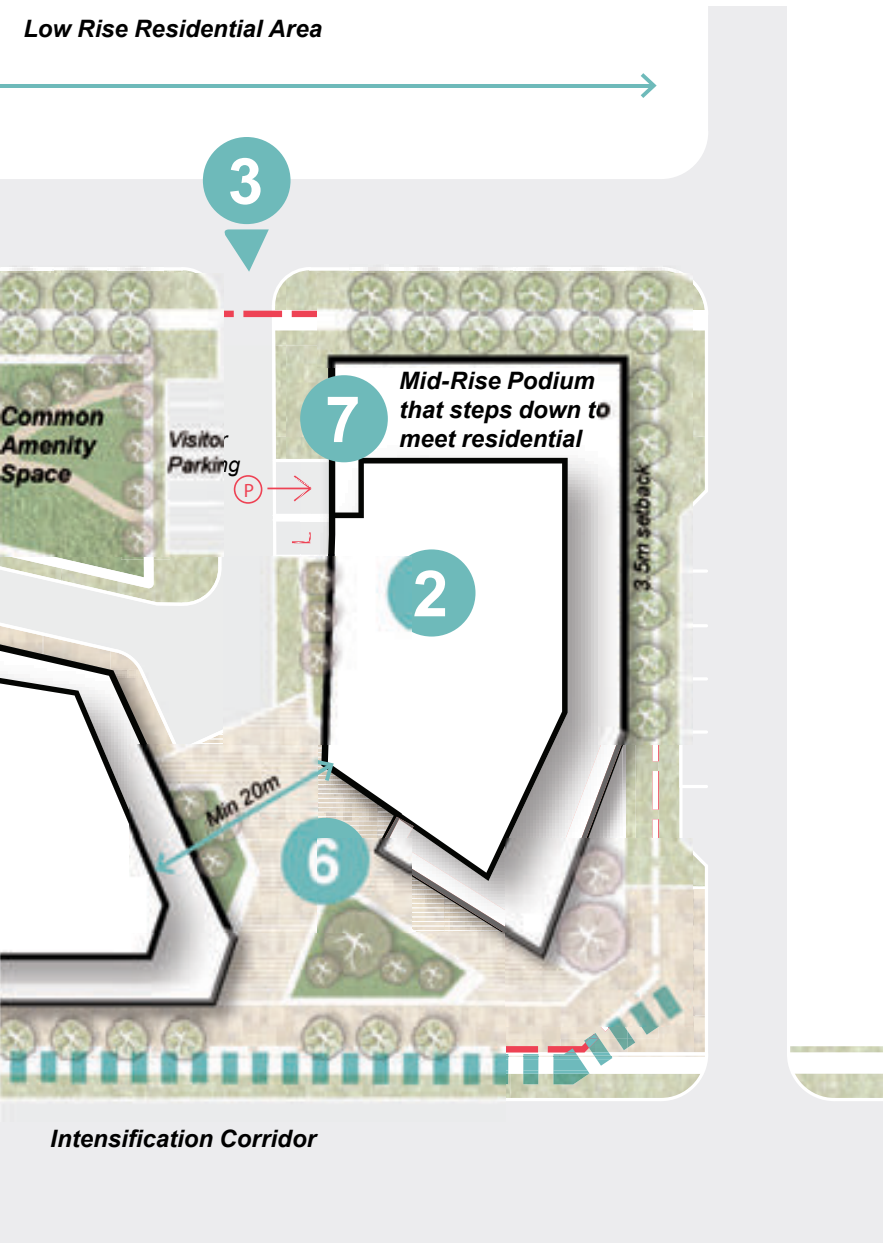

Design Principles:

- 1** High-Rise residential buildings are located along the intensification corridor with Mid-Rise podiums. The building design has a mix of setbacks and stepbacks to create a streetwall that varies in massing, scale and treatment
- 2** High-Rise employment buildings with Mid-Rise bases are located along the intensification corridor
- 3** Primary vehicular and servicing access driveways are located along minor streets
- 4** A new right-in-right-out street connection is provided to break up the long block and connect to the neighbourhood to the north. Approvals process would examine need for a mid-block public road or pathway connection with City Staff.
- 5** Low-Rise development is located along the northern edge of the site to transition to the Low-Rise residential community (within a 45° angular plane). Primary facades are indicated with a solid orange line.
- 6** Central courtyards and open spaces provide semi-private outdoor spaces for residents and employees.
- 7** Minimize vehicular traffic through the site by locating servicing and loading in close proximity to entrance roads.

Urban Design Approach for Demonstration Plan #3

High and Mid-Rise, Mixed-Use Development with Employment and Residential

| <i>Design Priorities (from Section 3.1)</i> | <i>Approach to Meeting the Design Priority</i> |
|--|---|
| Priority 1 - Enhance and Protect Vaughan's Natural Heritage Network | <p>This hypothetical site is not located in proximity to an existing natural heritage network or open space (in an urban design brief this would be demonstrated through the Context Plan (Section 4.2.1)).</p> <p>In this case, the focus on meeting this design priority is on climate change mitigation and introducing L.I.D. techniques to the front yard setbacks and open space designs.</p> |
| Priority 2 - Respond to Site Context | <p>There are a number of site criteria that have shaped this demonstration design. These include:</p> <ul style="list-style-type: none"> • The site fronts onto an intensification corridor, so an expanded front yard setback of 10m is being used to establish a double row of continuous trees along the street, as well as L.I.D. opportunities. • At-grade retail uses encroach up to 50% along the building length. As an active use at grade those retail uses and the podium above them are permitted to encroach up to 50% into the 10m front yard setback. • Through the location of parking below grade, a new semi public open space is provided to animate the retail edges and provide social outdoor space for the development. |
| Priority 3 - A Well Scaled City as a Liveable Environment for People | <p>There are a number of key rules that have informed the type, massing and organization of the buildings. These include:</p> <ul style="list-style-type: none"> • The upper parts of the mid-rise podiums are set back from the adjacent residential areas and street to maintain an appropriately scaled development (maintaining a 45 degree angular plane to the rear of the property). • The streetscape is framed through a series of building massings that break up the overall length of the buildings and provide a visual diversity to the development. In some cases the High-Rise buildings sit on a Mid-Rise podium, and in some cases they sit directly on the ground. |

Priority 4 - A Well-Connected Network that is Safe, Comfortable and Accessible

The organization of the site looks to achieve a well-connected site design by:

- Transitioning the project into two well scaled building blocks that are organized by a series of semi-public open space.
 - Future residential use is balanced with office use to support living and working in the same area.
 - At the corner is a semi-public open space that is connected to the centre of the site. The open space is framed by retail uses at grade.
 - Connecting the semi-public open space to the adjacent streets through clearly defined walking paths and pedestrian crossings.
 - Planning separate below grade parking garages for each building to allow for undisturbed soil in the eastern common amenity space. This contributes to long term mature tree growth.
 - Orienting the buildings in such a way that promotes clear views through the site and towards the building entrances.
-

Priority 5 - Promote High Quality Architecture

Many elements of High Quality Design are articulated in the Site Plan Approval and Zoning By-Law Amendment stages. These criteria will include meeting the performance standards and guidelines in sections:

- 5.3.1 Buildings on Intensification Corridors
 - 5.3.2 High-Rise Building Envelope
 - 5.3.3 Mid-Rise Building Envelope
 - 5.3.6 Built Form Transitions
 - 5.3.8 Thresholds and Entrances
 - 5.3.9 Facade Design and Materials
 - 6.2.5 Urban Squares
 - 6.1.2 The Green Approach on Intensification Corridors
-

Priority 6 - Frame an Active Public Realm and Pedestrian Environment

To achieve this Design Priority new buildings will be designed to integrate with public spaces, amenity spaces and streetscapes. The design of the site and the ground floor of buildings should be welcoming to the public with retail wrapping the buildings at grade. This creates a seamless transition between private and public spaces and supports a vibrant public realm in both the residential and employments areas.

Demonstration Plan #4a Prestige Industrial / Employment Building

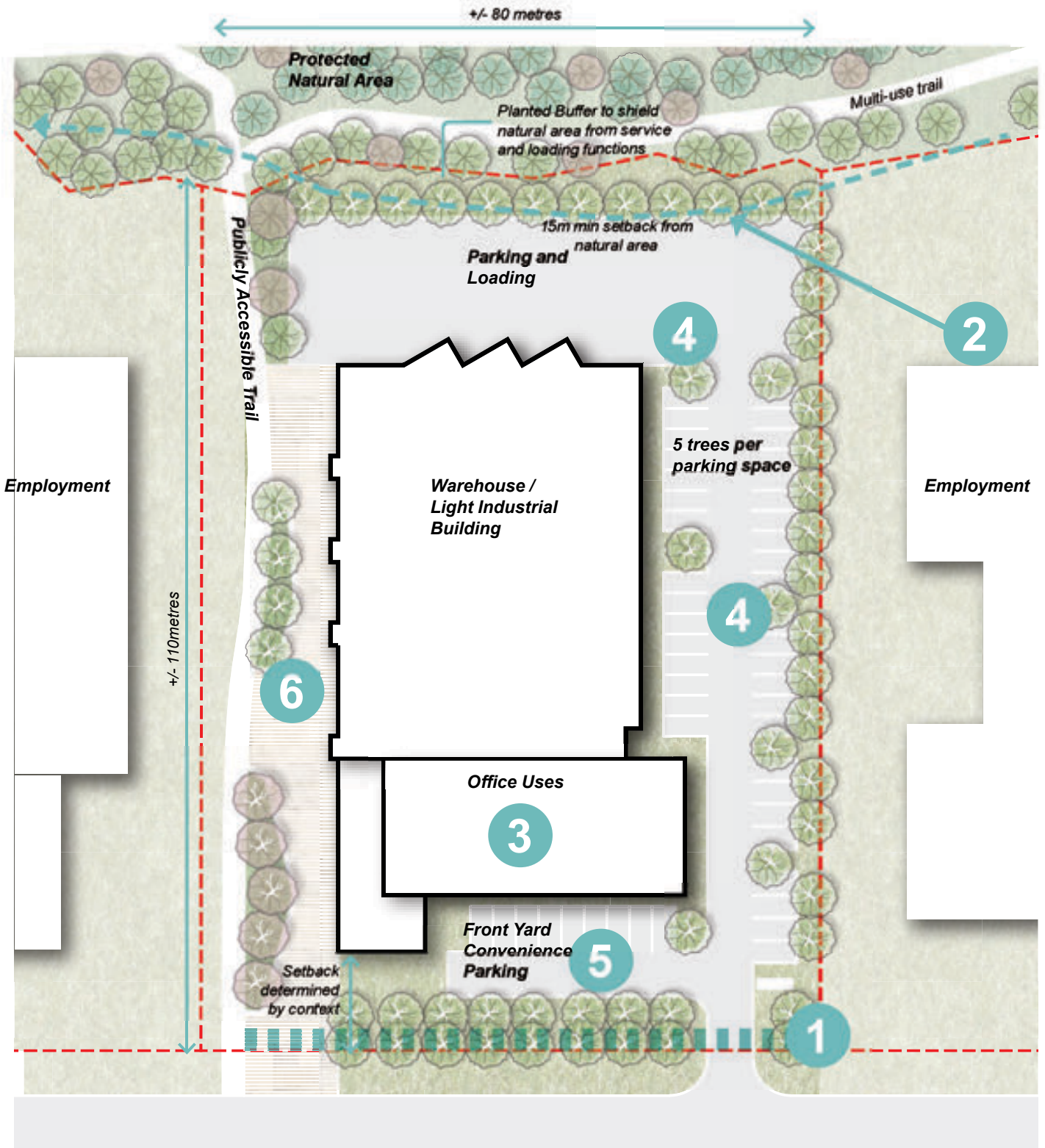

Design Principles:

- 1** In support of Vaughan's Green Approach, the front yard setback area (width to be determined through the review of the surrounding context) is landscaped with a high quality landscaped buffer that supports pollinators and on-site storm water management techniques (highlighted with a dashed green line).
- 2** A large setback from the existing natural heritage feature (as determined by the City and Conservation Authority) is maintained with walking trail connections as appropriate.
- 3** Office uses face the street to ensure active building areas front onto the street, as well as to provide easy wayfinding on the site. Warehouse uses are located at back of the property.
- 4** Parking is located at the side of the property and is visually screened from the street.
- 5** Some front yard convenience parking can be provided with an upgraded landscape design. Servicing and loading is provided at the back of the property, away from the street.
- 6** An open space is provided for staff along the property line and connects the street to the natural feature at the back.

Demonstration Plan #4b

Prestige Industrial / Employment Building on to a 400 Series Highway - Naturalized Buffer

Design Principles:

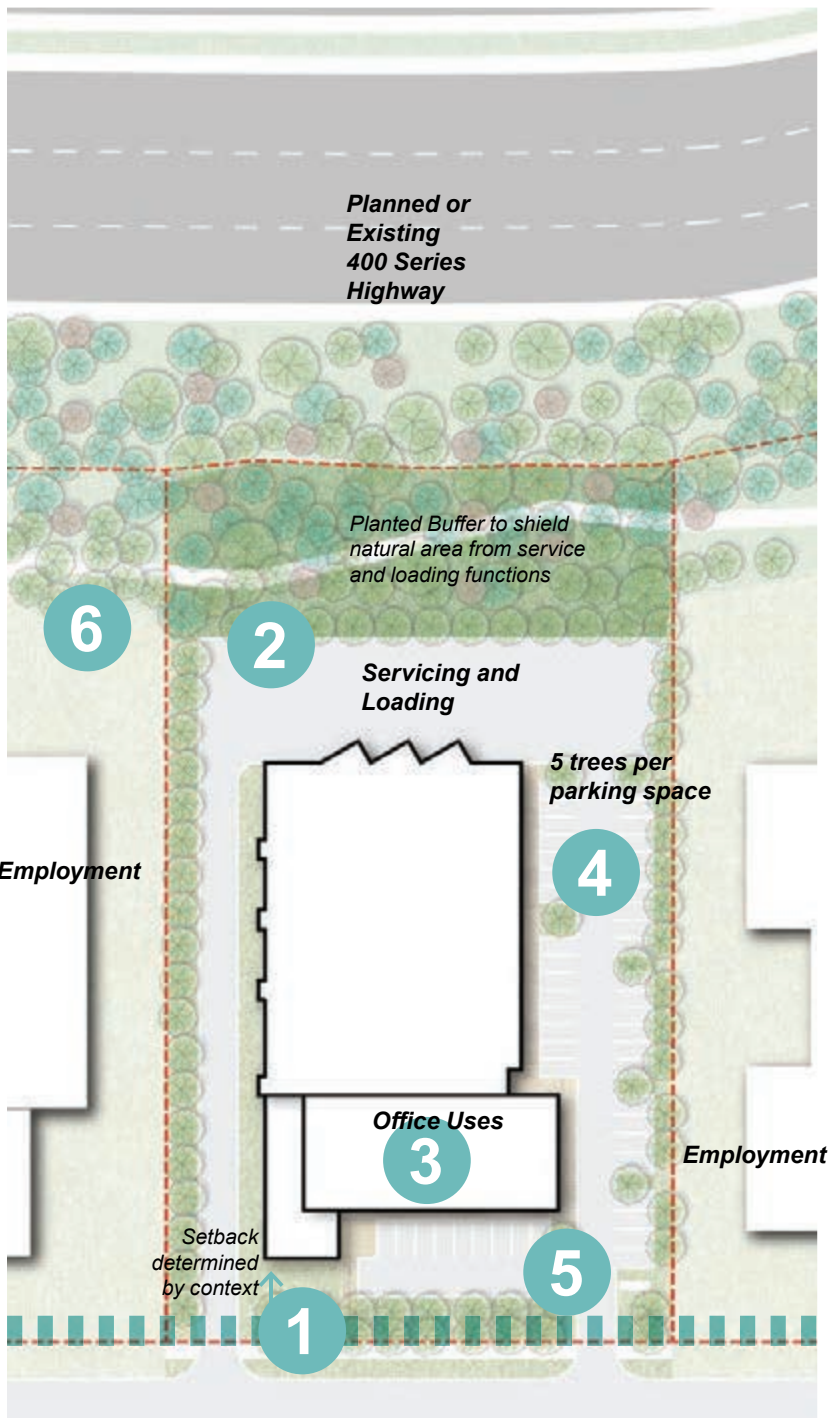

- 1 In support of Vaughan's Green Approach the front yard setback area (width to be determined through the review of the surrounding context) is landscaped with a high quality landscaped buffer that supports pollinators and on-site storm water management techniques (highlighted with a dashed green line).
- 2 Loading, storage and services area are buffered from view by a 20m naturalized setback from the existing or planned 400 Series Highway. Planting includes a mix of deciduous and coniferous trees.
- 3 Office uses face the street to ensure that active building areas front onto the street, and to provide easy wayfinding on the site.
- 4 Parking is located at the side of the property and is visually screened from the street.
- 5 Some front yard convenience parking can be provided with an upgraded landscape design. Servicing and loading is provided at the back of the property away from the street.
- 6 The planted buffer area can be the site of a future trail network to help improve upon connectivity and create additional recreation opportunities.

Demonstration Plan #4c

Prestige Industrial / Employment Building on to a 400 Series Highway - Naturalized Buffer

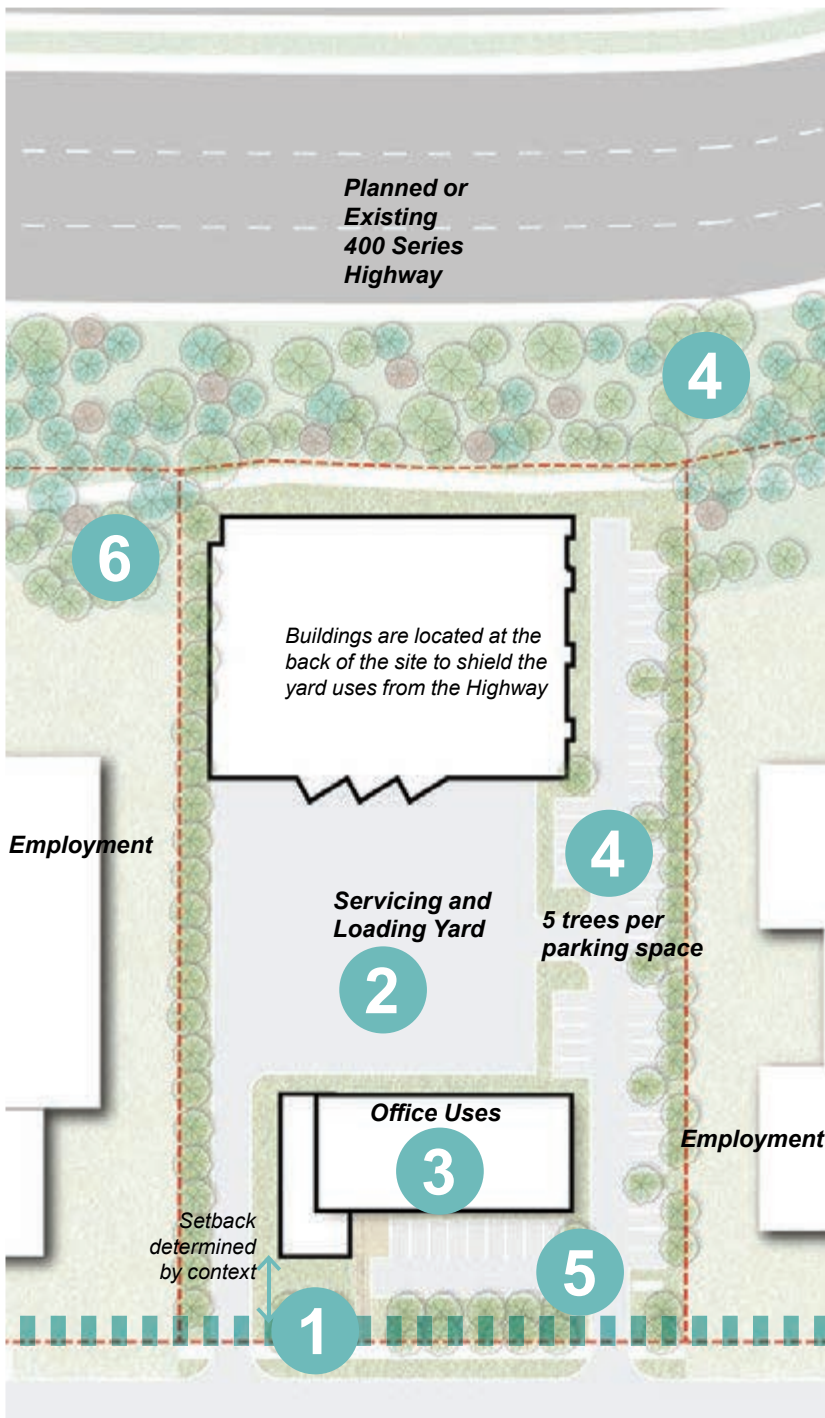

Design Principles:

- 1** In support of Vaughan's Green Approach, the front yard setback area (width to be determined through the review of the surrounding context) is landscaped with a high quality landscaped buffer that supports pollinators and on-site storm water management techniques (highlighted with a dashed green line).
- 2** Loading, storage, and service areas are buffered from view by the warehouse or office facility adjacent to the existing or planned 400 series highway. Design of the buildings should be visually interesting.
- 3** Office uses face the street to ensure active building areas front onto the street, as well as to provide easy wayfinding on the site.
- 4** Parking is located at the side of the property and is visually screened from the street.
- 5** Some front yard convenience parking can be provided with an upgraded landscape design. Servicing and loading is provided at the back of the property away from the street.
- 6** The planted buffer area can be the site of a future trail network to help improve upon connectivity and create additional recreation opportunities.

Urban Design Approach for Demonstration Plan #4a,b,c Prestige Industrial / Employment Building Backing onto a Natural Area

| <i>Design Priorities (from Section 3.1)</i> | <i>Approach to Meeting the Design Priority</i> |
|--|---|
| Priority 1 - Enhance and Protect Vaughan's Natural Heritage Network | <p>Hypothetical site 4(a) backs onto an existing Natural Heritage Network (in an urban design brief, this would be demonstrated through the Context Plan (Section 4.2.1)). In this case, in addition to focusing design measures that address climate change mitigation, measures would introduce L.I.D. techniques in the front yard setbacks and open space designs. This site is located within an area where it is a priority to establish publicly accessible trail connections to the existing multi-use trail located within the natural area. The natural character of the landscaping reflects the adjacency of the Natural Heritage Network. A planted buffer of trees and landscaping shields the industrial storage, loading and service yard from the natural area.</p> <p>Hypothetical sites 4(b) and 4(c) back onto a 400 series highway (existing or planned). In the case of these demonstration plans, the focus is on climate change mitigation and introducing L.I.D. techniques in the front yard setbacks and open space designs.</p> |
| Priority 2 - Respond to Site Context | <p>There are a number of site criteria that have shaped this demonstration design. These include:</p> <ul style="list-style-type: none"> • The front yard setback is consistent with the surrounding conditions. • A side yard open space animates the public trail connections and locates active uses facing the trails. • The front yard setback is naturalized and employs L.I.D. technologies, focused on managing stormwater on site. |
| Priority 3 - A Well Scaled City as a Liveable Environment for People | <p>There are a number of key rules that have informed the massing and organization of the site. These include:</p> <ul style="list-style-type: none"> • For concept 4(a), the active office uses are moved to the front of the site to frame the street and provide windows onto the side yards and trail. • The larger warehouse uses are either placed at the back of the site, or connected to the office uses. |

Priority 4 - A Well-Connected Network that is Safe, Comfortable and Accessible

The organization of the site looks to achieve a well-connected site design by:

- Continuing the setback provided in the adjacent properties.
- Providing walking connections around the building with easy access to entrance and clear wayfinding.
- Framing public trails, and streets with active building uses, with windows facing onto public spaces.
- Discreetly locating some convenience parking in front of the building. However, the majority of the parking is located at the side or back of the building.

Priority 5 - Promote High Quality Architecture

Many elements of High Quality Design are articulated in the Site Plan Approval and Zoning By-Law Amendment stages. These criteria will include meeting the performance standards and guidelines in sections:

- 5.3.6 Built Form Transitions
- 5.3.8 Thresholds and Entrances
- 5.3.9 Facade Design and Materials
- 6.1.1 The Green Approach
- 7.6.2 Employment/Industrial Buildings
- 7.6.3 Prestige Employment Buildings

Priority 6 - Frame an Active Public Realm and Pedestrian Environment

To achieve this Design Priority, this will be designed to integrate with public spaces, amenity spaces and streetscape design. The design of the site and the building should be visually interesting with unique roof shapes, clean proportions and materials. Although these buildings sites are not always in urban areas, the site should be designed as visually interesting developments within the City.

Demonstration Plan #5 Mixed Unit Type Townhouse Development

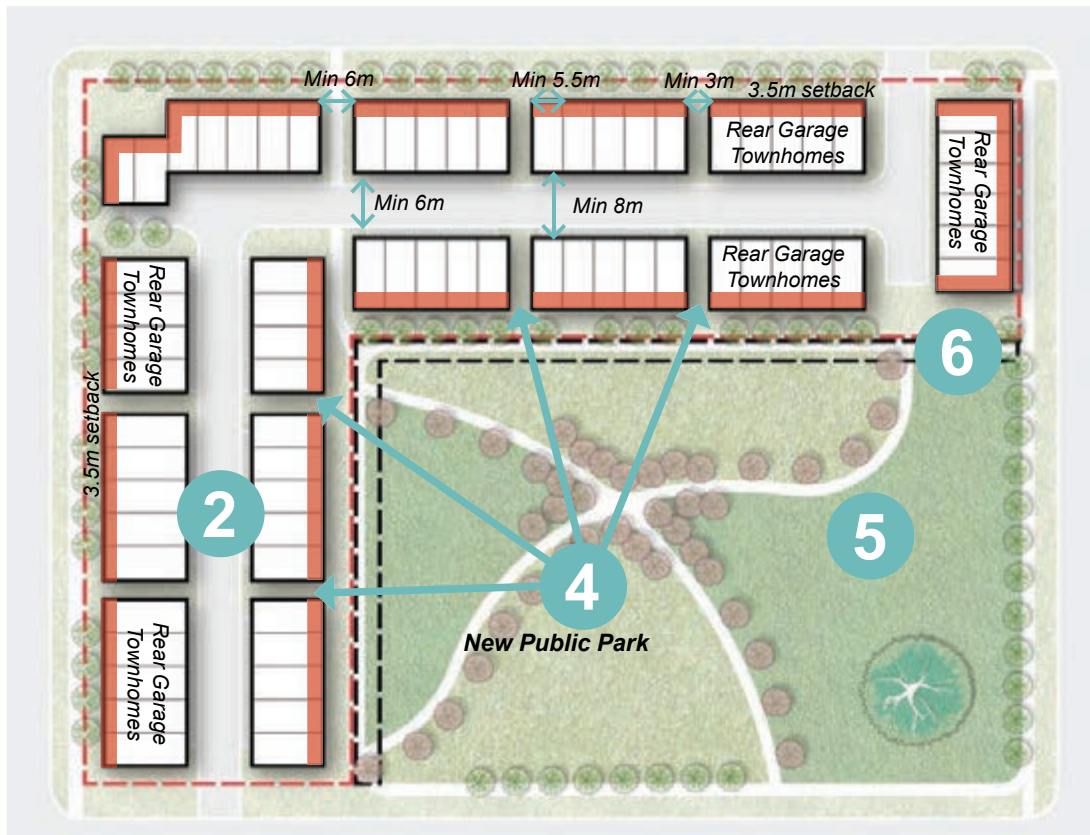

Rear Garage Townhouses with New Public Park

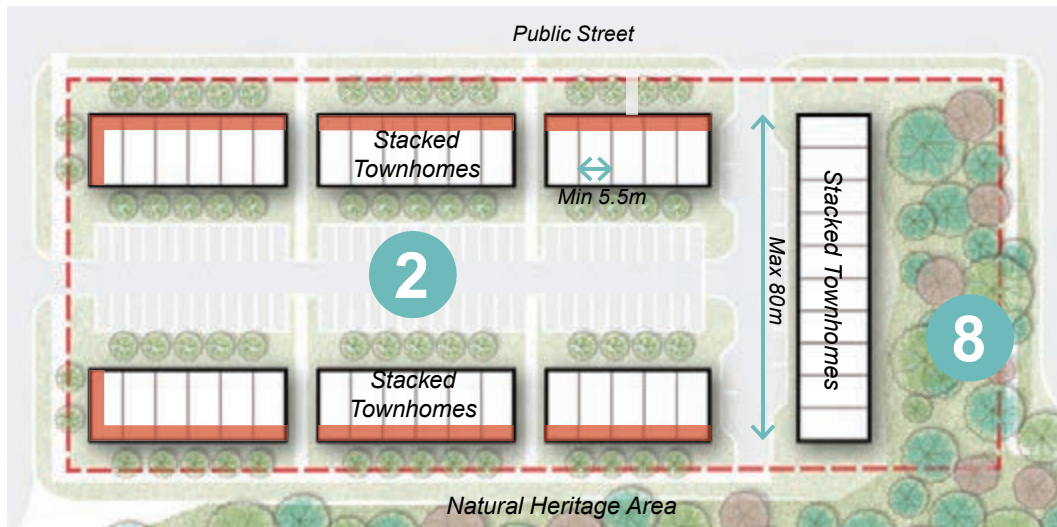

Stacked Townhouses

Design Principles:

- 1 Back-to-back townhouses are located along the property line facing the street with underground parking.
- 2 Town houses with garages accessed from a rear lane frame the edge of the park, the natural heritage corridor, and the adjacent streets.
- 3 A private road extends the streetscape seamlessly into the townhouse block including sidewalks, tree planting and active streets with windows and front yards facing the private street.
- 4 Mid-block connections break up large sites and ensure that the area is well connected for pedestrians and cyclists.
- 5 The new public park is framed by a strong street wall on two sides and roads on two sides with no back lotting. Where feasible, parks should achieve 50% public street frontage.
- 6 A 6 metre servicing access block should be provided to address private access, lighting, landscaping, stormwater requirements, low impact development, or any other servicing required for the development block and shall be designated in consultation with Engineering and Operations.
- 7 A network of public streets breaks the development into accessible and appropriately scaled blocks.
- 8 Existing natural areas are connected through the development parcels and reinforced with strong connections to a new central park space.

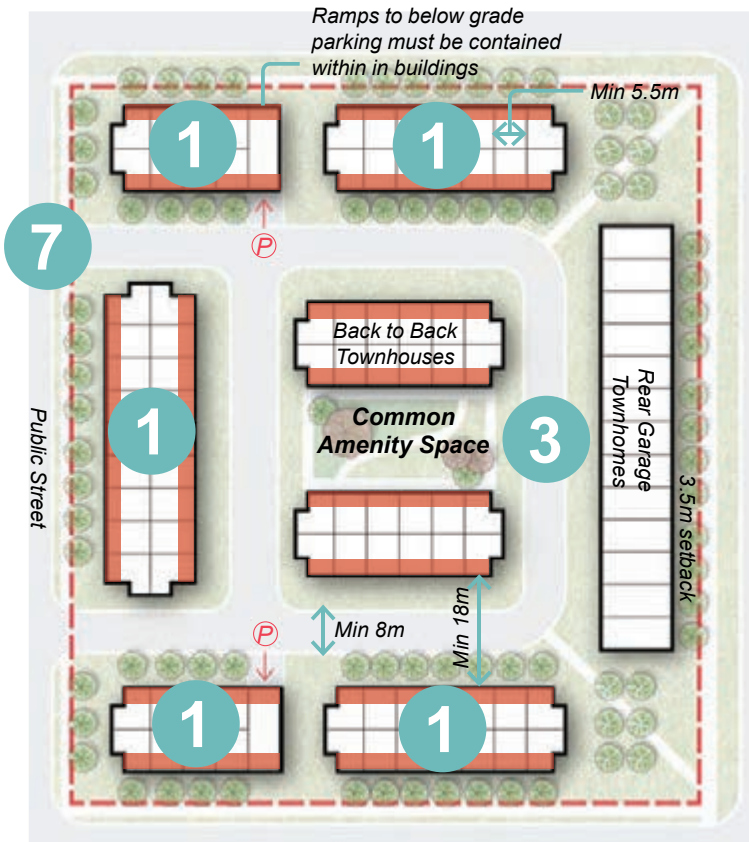

Back to Back Townhouses and Rear Garage Townhouses

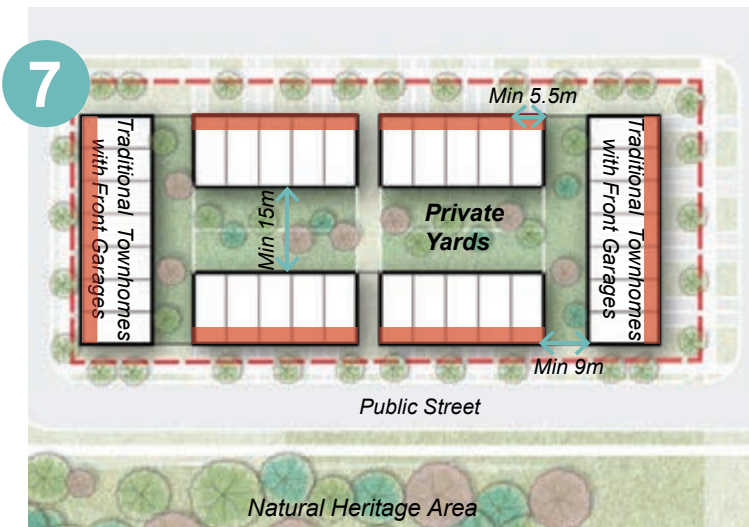

Traditional Townhouses with Front Garages

Urban Design Approach for Demonstration Plan #6

Mixed Unit Type Townhouse Development

| <i>Design Priorities (from Section 3.1)</i> | <i>Approach to Meeting the Design Priority</i> |
|---|---|
| Priority 1 - Enhance and Protect Vaughan's Natural Heritage Network | This hypothetical site is located in proximity to an existing Natural Heritage Network (in an urban design brief this would be demonstrated through the Context Plan (Section 4.2.1)). There is an opportunity to extend and connect the natural area to the central public park. |
| Priority 2 - Respond to Site Context | There are a number of site criteria that have shaped this demonstration design. These include: <ul style="list-style-type: none"> • This site is located within predominantly residential areas and it is not within a growth area. • New residential development is laid out to create a network of new public streets. Sites that include below grade parking have private streets at grade. • All streets are fronted with the primary residential frontages (shown in red). |
| Priority 3 - A Well Scaled City as a Liveable Environment for People | There are a number of key rules that have informed the type, massing and organization of the buildings. These include: <ul style="list-style-type: none"> • Back to back townhouses are used in tight site coordination where a dual frontage is essential to achieve a positive site character. • Surface parking is located at the interior of blocks, and never faces streets or open spaces. |
| Priority 4 - A Well-Connected Network that is Safe, Comfortable and Accessible | The organization of the site looks to achieve a well-connected site design by: <ul style="list-style-type: none"> • Transitioning the project into two well-scaled buildings that frame a semi-public open space. • Connecting the semi-public open space to the adjacent streets through clearly defined walking paths and pedestrian crossings. • The new public park and amenity areas are framed with primary building facades that will have front doors and windows facing the open spaces. • Mid-block connections are provided to encourage site permeability, especially in order to create strong connections to the public park. |

Priority 5 - Promote High Quality Architecture

Many elements of High Quality Design are articulated in the Site Plan Approval and Zoning By-Law Amendment stages. These criteria will include meeting the performance standards and guidelines in sections:

- 5.3.4 Low-Rise Building Envelope
- 5.3.5 Townhouse Design
- 5.3.6 Built Form Transitions
- 5.3.7 Separation Distances
- 5.3.8 Thresholds and Entrances
- 5.3.9 Facade Design and Materials
- 6.1.1 The Green Approach
- 6.2.2 Private Grade-Related Amenity Spaces + Courtyards
- 6.2.5 Urban Squares
- 7.3.2 Townhouses

Priority 6 - Frame an Active Public Realm and Pedestrian Environment

To achieve this Design Priority, new Low-Rise buildings will be designed to integrate with public spaces, amenity spaces, and streetscapes. The design of the site and the orientation of buildings should always consider the pedestrian experience first. Well-designed Low-Rise development should create a clear transition between private and public spaces, and should support a vibrant public realm.

Section 4: **SITE CONTEXT**

4.1 Context Analysis

Context analysis should guide the design of sites, landscapes and buildings to ensure that new developments integrate seamlessly with their surroundings.

The design of new development in Vaughan must respond to its context. This is done through consideration of streets and blocks, adjacent built form and uses, natural systems and view corridors. These considerations should be the foundation of the design process so that new developments are compatible with their existing and planned surroundings and contribute to developing a cohesive and unique identity for Vaughan.

Analysis of existing and planned context within a 400-800 metre radius should be the first step in designing any new site or building. This analysis will provide important cues that will guide the design and development of relationships between circulation networks, natural connections, open spaces, buildings, transitions and buffers.

4.2 Methodology

Undertaking a Context Analysis for a new development will form part of an Urban Design Brief, which will be submitted and reviewed by the City of Vaughan as part of a complete development application package.

Context analysis should consider both existing conditions as well as the future planned vision. In areas where there is a vision for significant change, like Secondary Plan Areas and Intensification Areas, understanding the future vision is particularly critical.

The Terms of Reference for an Urban Design Brief can be found in the Technical Reference Manual online.

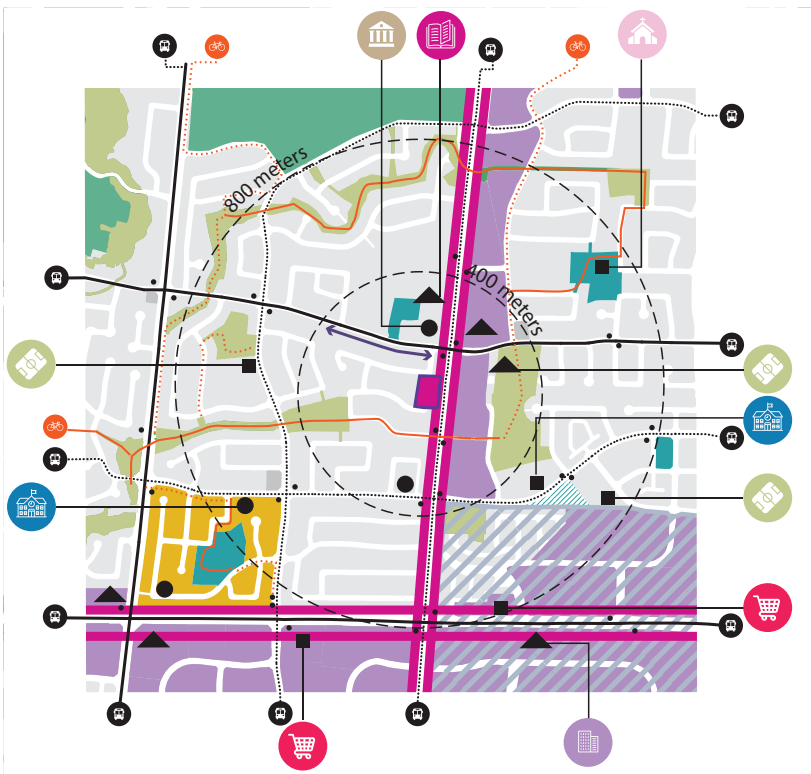

Sample Context Mapping Diagram

4.2.1 Context Mapping

New developments will be expected to respond carefully to site and area conditions, including natural heritage, existing landscape, built development and circulation networks. All development applications should include context mapping, showing the development site within a 400 to 800 metre radius. This radius is generally considered to be a 5 to 10 minute walk, and will encompass key features or places that will be used by future users of the site or elements that should influence site design. Any deficiencies found during the Context Mapping Exercise would be addressed by providing additional on site amenities and services. The area of analysis should be determined based on the scale of the site and surrounding features. Context mapping will inform streetscape improvements within setbacks along intensification corridors as well as contributing to the implementation of existing planning documents such as the Vaughn Active Together Plan and Pedestrian and Bicycle master Plan.

As part of the Context Mapping, site specific mapping should be prepared as part of the Urban Design Brief and the complete development application, to identify

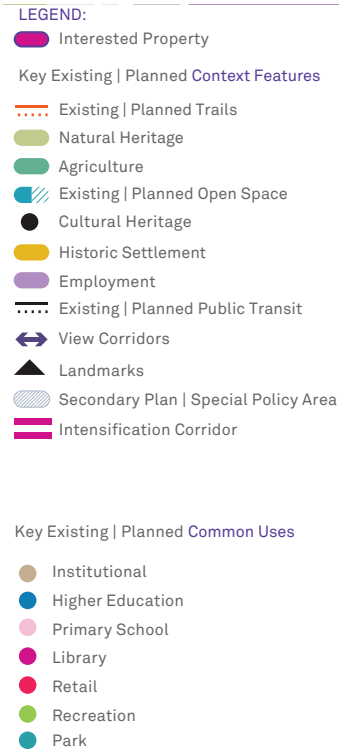

the following existing and planned elements and features:

- Key existing and planned pedestrian, vehicular, transit, trail (particularly Vaughan Super Trail) and cycling connections and access points, including mid-block connections and transit stops;
- Streetscape design;
- Key destinations, heritage buildings, community facilities and other amenities;
- Open spaces, natural heritage features, parks and other public spaces;
- Key landmarks, view corridors and view termini;
- Important topographical elements;
- Land uses and key zoning permissions, including permitted building heights;
- Building massing;
- Streetwall heights;
- Typical block and lot sizes;
- Existing/planned trails or active transportation facilities; and
- Other relevant features on a site specific basis.

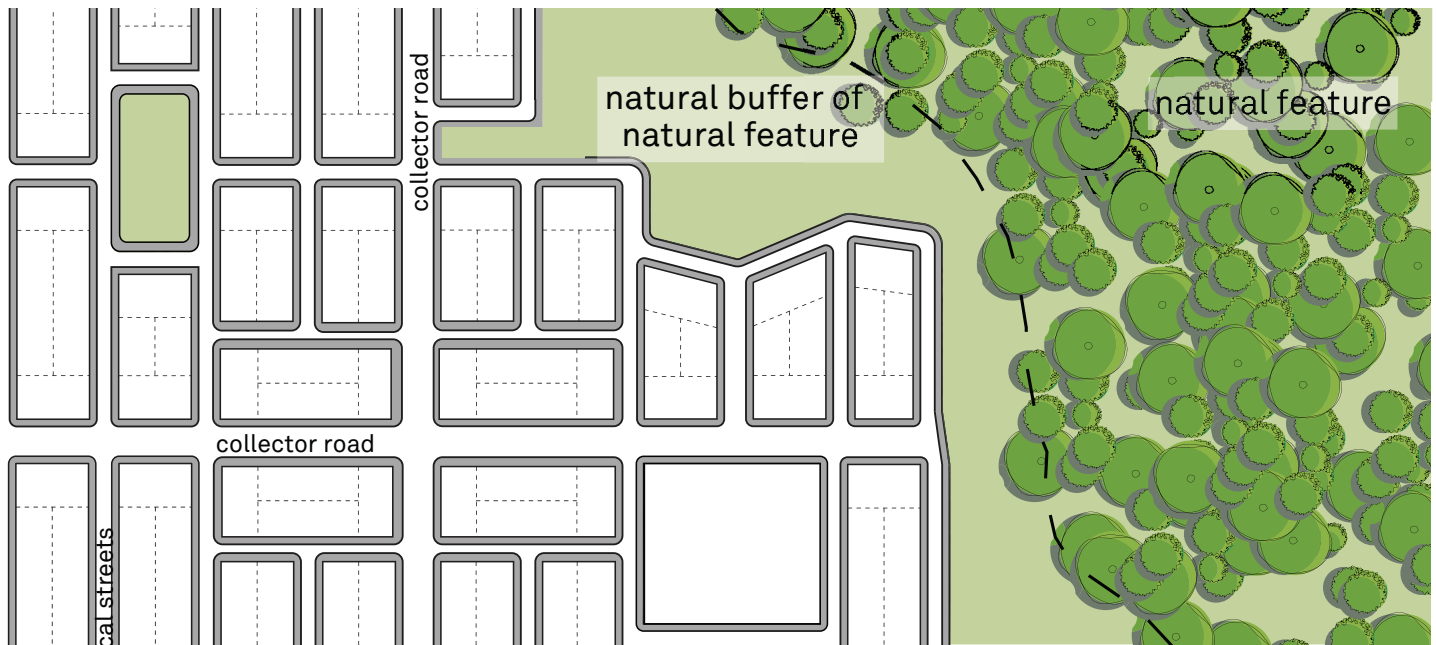

Example scale for a block level diagram

4.2.2 Block-Level Design for Larger Sites

Development applications shall also include block level design diagrams showing the proposed development within its context to demonstrate how it responds to key elements and features identified in Section 4.2.1.

Larger sites should prepare a development concept plan to illustrate how the overall development responds to context, creates positive relationships within the site, and supports the existing vision for the area. Similar to a Development Concept Report, these requirements will illustrate how the proposed development responds to design considerations outlined in the City-Wide Urban Design Guidelines, rather than a Secondary Plan. A development concept plan may be required for sites that:

- Consolidate multiple properties or are unusually large;
- Will be developed in multiple phases;
- Create new public streets, parks or open spaces; or
- Have other complex site conditions.

Block level diagrams should illustrate:

- Block and lot length and width;
- Building footprints with dimensions, heights, setbacks and facing distances;

- Shadow analysis for High- and Mid-Rise buildings;
- Open spaces, natural heritage features and parks;
- Existing trees on the subject site and adjacent sites;
- A landscape plan shown in context with the adjacent landscape;
- Access and circulation networks, including pedestrian, cycling and transit connections and required mid-block connections;
- Connections to adjacent existing and planned circulation networks;
- Relationships and access with adjacent buildings, open spaces, parks, trails, agricultural and/or natural heritage features, including required buffers;
- Relationships to adjacent heritage resources;
- Parking for all modes and servicing, including the number of surface parking spaces, if applicable;
- Utility placement and municipal servicing including L.I.D. measures and consideration of district energy considerations; and
- A phasing plan, if applicable.

4.3

Public Realm Framework

New developments shall respond to and extend key elements of the public realm through the design of the site and through relationships to adjacent properties and public spaces.

The Performance Standards contained in this section are intended to ensure that new developments integrate seamlessly with the adjacent context, connect with urban and natural networks, enhance public access to amenities and create a consistent and coherent public realm.

This section includes Performance Standards for:

- Streets and Blocks
- Lot Sizes and Variety
- Landmarks and Views

As well as Performance Standards for development adjacent to:

- Natural Heritage Networks
- Trails
- Agriculture
- Cultural Heritage
- Park Frontage
- Employment and/or Highway

Performance Standard No. 4.3.1 Streets and Blocks

Streets and blocks should provide permeability for pedestrians, cyclists and vehicles and promote a connected and continuous grid-like street network. The development of large blocks should encourage public access through the creation of a network of smaller blocks and streets and/or through mid-block connections.

- a. The location of streets and mid-block connections should extend logically into adjacent areas and connect directly with transit stops, trails, public sidewalks, community amenities, parks and open spaces.

Key Dimensions:

- b. Where new blocks are created, they should be a maximum of 250 metres in length to promote walkable blocks.

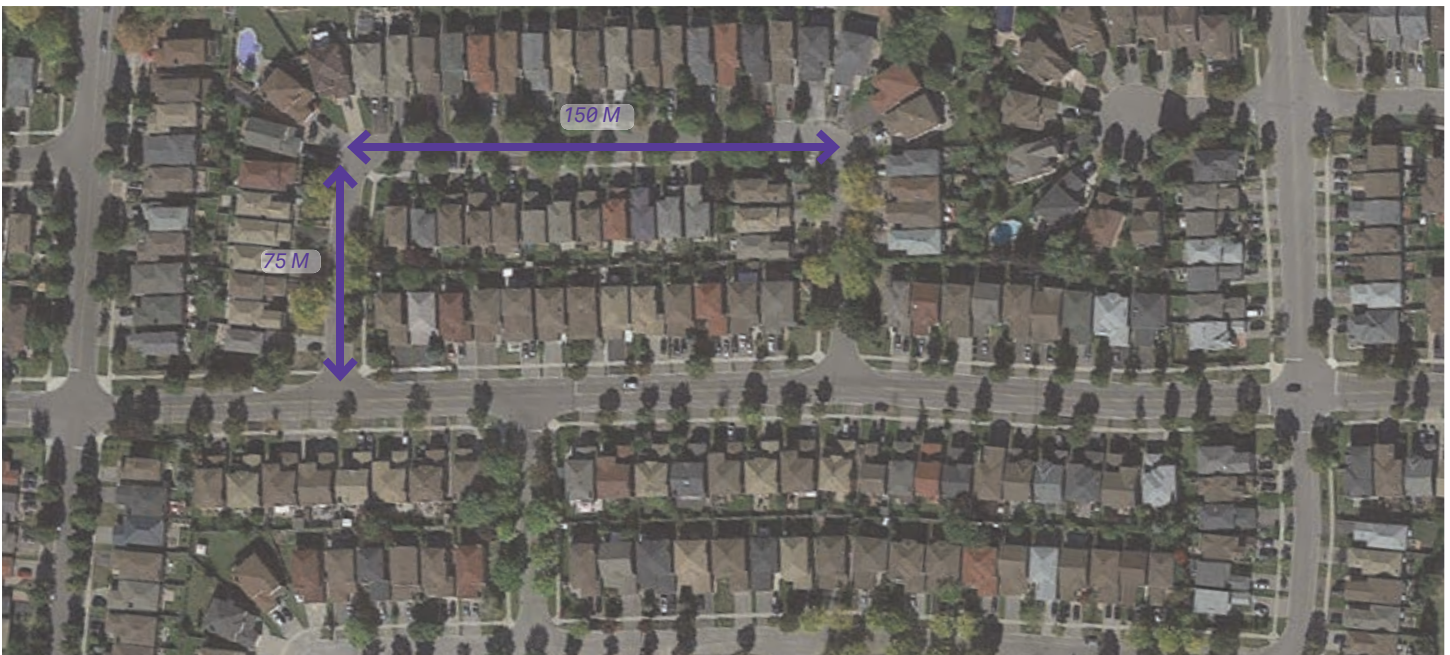

Street connections and smaller block sizes should provide permeability and connectivity through neighbourhoods. Blocks should be no greater than 250 meters in length. (Mountfield Crescent in Thornhill. Image Credit: Google Earth).

Performance Standard No. 4.3.1 (continued)

Streets and Blocks

- c. Block lengths greater than approximately 150 metres should be broken up through the provision of mid-block connections to ensure the traversable length is no more than 75 metres. The connection should provide pedestrian and cycling access, and may provide a vehicular connection depending on the context.
- d. When adjacent buildings have no windows facing the shared property line, mid-block connections should be a minimum of 6 metres. Mid-block connections should be a minimum of 15 metres when adjacent buildings have windows.

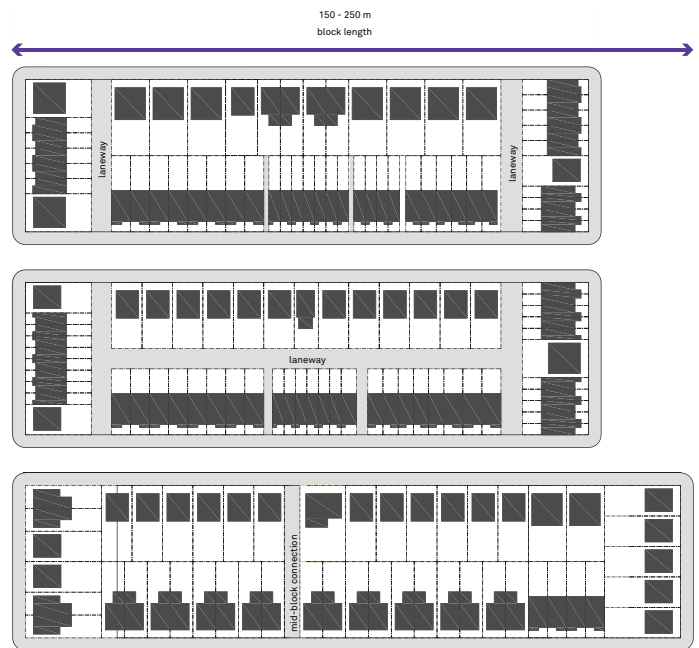

Block length should not exceed 250 metres. Where block length is greater than 150 metres, mid-block connections should be provided.

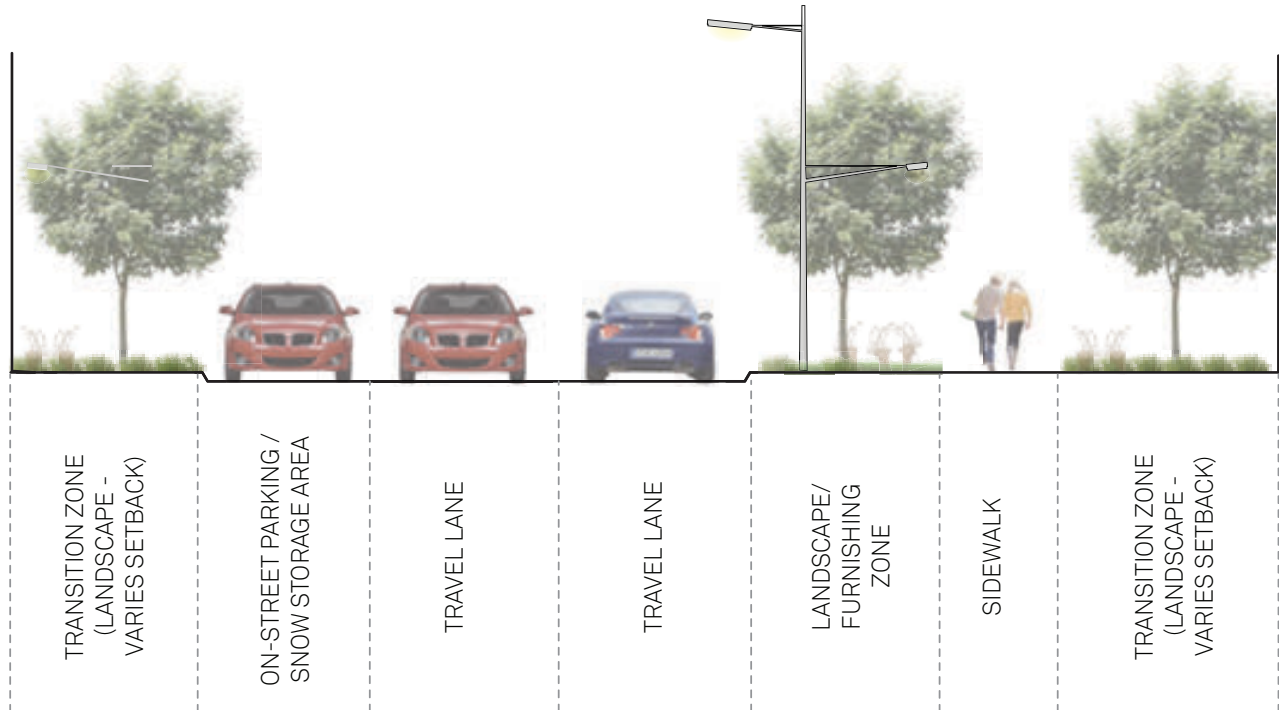

Private local roads should be designed to provide landscaped zones, a sidewalk on one side of the road, and on-street parking.

Key guidelines:

- Performance Standard 5.2.7 Private Roads
- Performance Standard 5.2.11 Mid-Block Connections/Mews

Key policy references:

- City of Vaughan Official Plan, Chapters 1, 4 and 9

Performance Standard No. 4.3.2

Lot Sizes and Variety

There are a wide variety of lot sizes within Vaughan. This diversity of site character provides the opportunity to respond to the surrounding context in many different ways. Ultimately this should result in a site specific approach to the site layout and building design with generous landscape and open space. Lots should be designed to promote a diversity of character in response to the surrounding context.

- a. On sites that include more than one building, consider the relationships of buildings within the site to each other as well as to adjacent buildings and spaces to create a cohesive site plan.
- b. In future Plans of Subdivision, provide a variety of lot sizes to ensure a diversity of building and open space types, forms, and designs, as well as permeability between lots.
- c. Simple and rectilinear shapes should be provided for optimal layout and site design.
- d. Where shallow lots exist, consider opportunities to share access and servicing infrastructure.
- e. Ensure that the proposed lot sizes and orientations protect for natural light, frame key views and reinforce existing and future connections to the surrounding area.
- f. In future plans of subdivision and block plans, protect the natural grading and topography of the site to the greatest extent.

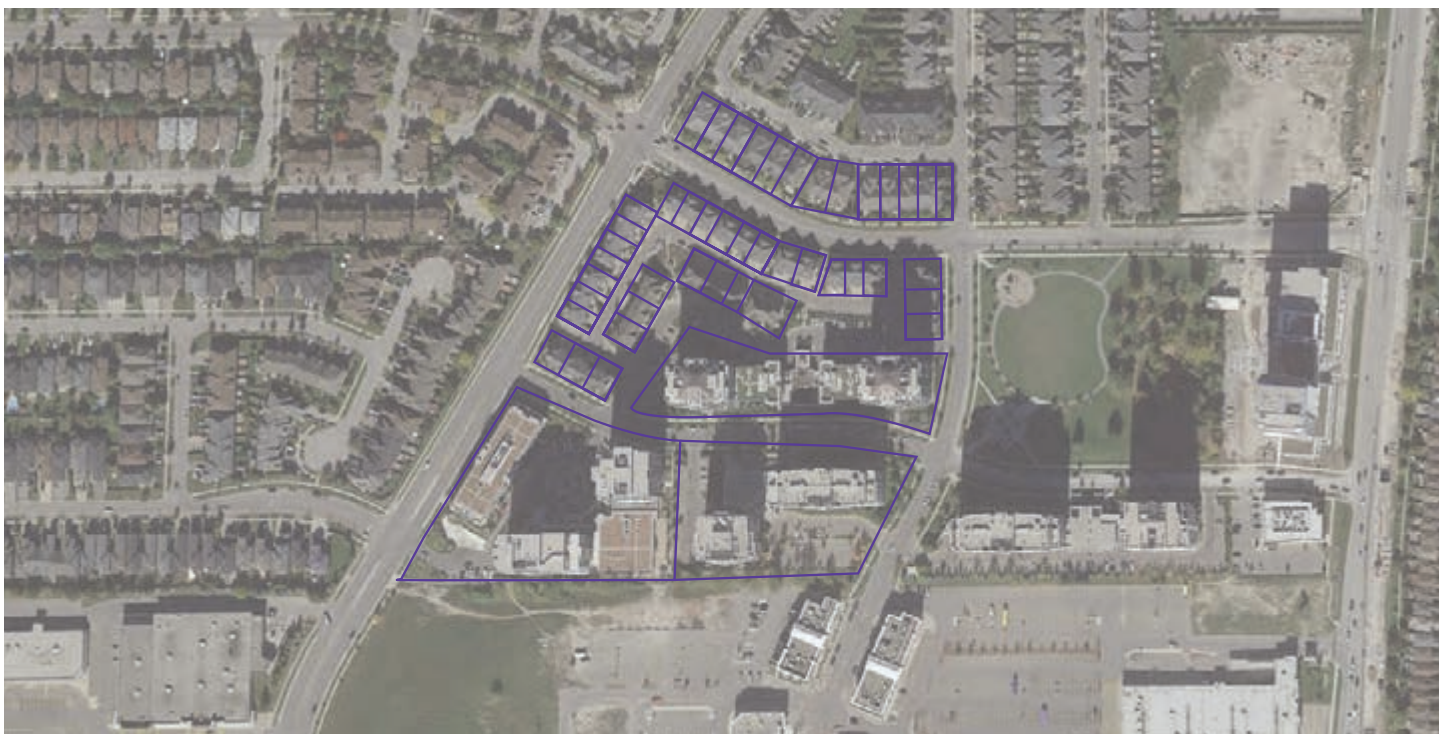

A variety of lot sizes permits a range of building forms, uses and design approaches (City of Vaughan. Image Credit: Google Earth)

Key guidelines:

- Performance Standard 4.3.1

Performance Standard No. 4.3.3 Landmarks and Views

Retention of key landmarks and views should be a priority when designing sites and locating buildings. Views and landmarks should be enhanced with public access, building design and complementary landscape.

- a. Retain or create views of important landmarks from public streets and spaces.
- b. Views to adjacent natural features, public art, parks and open spaces or other amenities should be enhanced with public access and landscape design.
- c. Where buildings frame view corridors, the frontages of buildings facing the corridor should be programmed with active uses to frame and enliven the street.
- d. Sites that terminate key view corridors should be designed to incorporate signature art or architectural treatments or building elements.
- e. Consider topography and elevation to identify locations for new view termini or locations from which views can be created.
- f. Changes in grade over a lot should be used to maximize views to and from buildings and create landmarks that are uniquely integrated into the landscape and existing topography.
- g. Consider appropriate transitions for buildings adjacent to heritage structures to allow for views of the building from the public realm.



The Vaughan City Hall Tower creates both a viewpoint and a view terminus. (Image Credit: City of Vaughan).

Key guidelines:

- Performance Standard 4.3.8 Development Adjacent to Open Space
- Performance Standard 5.2.9 Grading and Drainage

Key policy reference:

- City of Vaughan Official Plan, Chapter 9

Performance Standard No. 4.3.4 Development Adjacent to Trails

Vaughan's multi-use trail system connects residents to the Natural Heritage Network and provides space for recreation and active lifestyles within a naturalized environment. Development adjacent to trails should provide appropriate connections, buffers, and site organization to enhance the character of the trail.

- Prioritize public access to existing trails that connect to the natural heritage system. Development bordering a trail network should provide clearly visible and accessible entrances to the trails.
- Provide safe crossings wherever multi-use trails intersect with the road network with adequate signaling and changes in colour or materials to indicate priority crossings for pedestrians and cyclists.
- Trailheads should have a strong presence in the proposed neighbourhood.
- Where trails are proposed immediately adjacent to the proposed development (either residential, commercial or mixed-use), adequate buffers should be created with enough space to promote the growth of a mature tree canopy.
- Development should provide key connections to the Vaughan Super Trail or other community trails as identified by the Pedestrian and Bicycle Master Plan.



A riverfront trail provides space for pedestrians and bicyclists to travel alongside a major natural amenity. (Image Credit: Allegheny Riverfront Park, Michael Van Valkenburgh Associates Inc)

- Where required, private development should allow for public easements to ensure trail connectivity.

Key guidelines:

- Performance Standard 5.2.12 Pedestrian and Cycling Connections and Street Furnishings
- Performance Standard 5.2.13 Site Signage and Wayfinding
- Performance Standard 6.1.1 The Green Approach

Performance Standard No. 4.3.5 Development Adjacent to Natural Heritage

Vaughan's Natural Heritage Network provides multiple ecological benefits to the City and the Region, in terms of quality of life for residents and environmental sustainability. The interface between urban development and the Natural Heritage Network should consider the sensitivity of the natural area to inform appropriately designed transitions, vegetation protection zones, and site organization.

- a. Create public access and views to the Natural Heritage Network through the appropriate placement of roads, buildings and infrastructure, while ensuring minimal impact to the Natural Heritage Network.
- b. Integrate trails, public parks and open spaces into the Natural Heritage Network to create connections, public uses and support passive recreation. When amenity spaces are required, these must be provided in addition to passive recreation areas and buffer zones.
- c. Locate single loaded roads along the edge of the Natural Heritage Network, where feasible.
- d. Avoid rear yard backlotting of residential units onto the Natural Heritage Network.
- e. Control private access to Natural Heritage Network by incorporating boundary fencing, where trails are not permitted.
- f. Integrate active transportation networks to connect directly from public streets, bicycle lanes and sidewalks to trail networks in the Natural Heritage Network, where appropriate.
- g. Organize site elements so that view corridors at ground level into natural heritage features are maintained or created. These view corridors may include pedestrian connections to provide access, if appropriate.

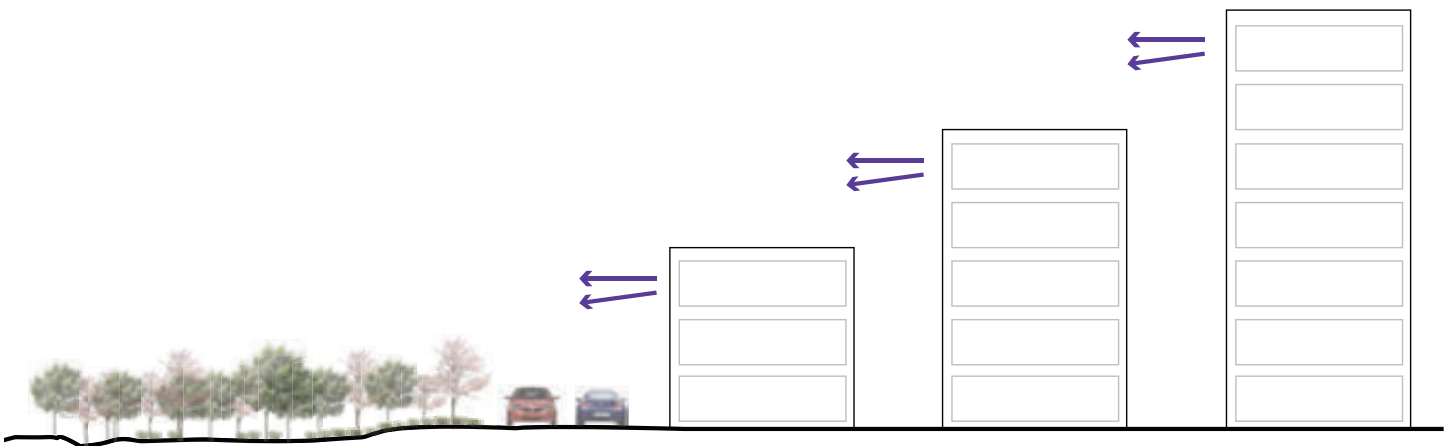

Significant public street frontage and connections through neighbourhoods provide views and access to natural heritage features.

Key guidelines:

- Performance Standard 4.3.4 Development Adjacent to Trails
- Performance Standard 5.2.12 Pedestrian and Cycling Connections and Street Furnishings
- Performance Standard 6.1.1 The Green Approach

Key policy references:

- City of Vaughan Official Plan 2010, Chapter 3

Performance Standard No. 4.3.5 (Continued)

Development Adjacent to Natural Heritage

- h. Building location, height and orientation should take advantage of views to the Natural Heritage Network for upper level units.
- i. Ensure that appropriate vegetation protection zones (in conformance with TRCA requirements) are included between sensitive natural heritage features and buildings or other site elements.
- j. Vegetation protection zones areas should extend the natural landscape character of adjacent features further into the site.
- k. Integrate Low-Impact Development measures at site edges to filter and clean stormwater run-off before it enters the natural heritage areas.
- l. Consider the movements of wildlife between natural areas to provide corridors and connect natural areas.
- m. Avoid fragmenting the Natural Heritage Network with roads and infrastructure, where possible.
- n. Site organization should promote the creation of trails within the natural heritage feature vegetation protection zone and outside of the natural features where possible.
- o. In most conditions, natural heritage areas should maintain a public frontage that is appropriately scaled to the size of the development and the opportunities for public access and amenities. A fully accessible natural heritage area should be a prominent feature at the street edge. However, protected non-accessible natural heritage areas should be buffered by vegetative protection zones.

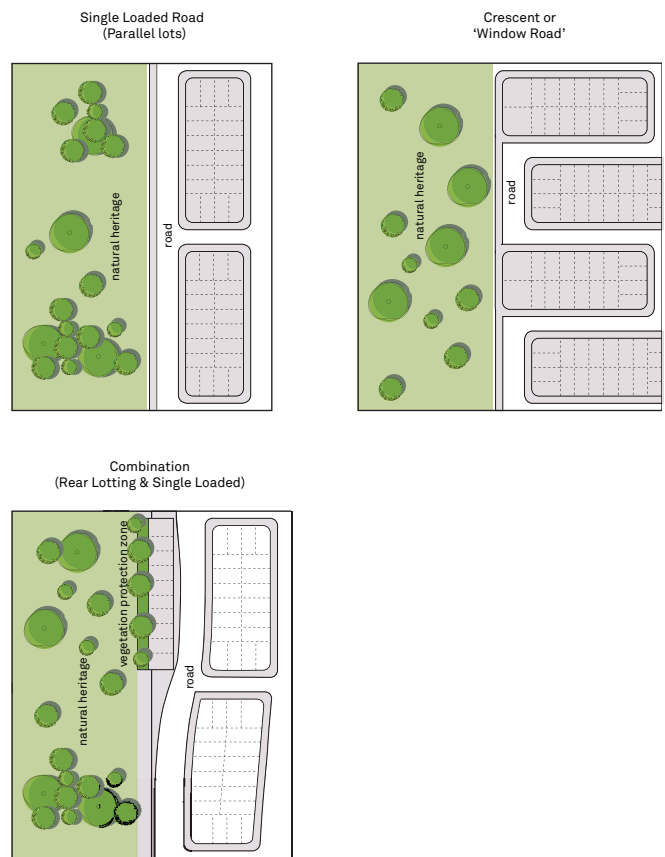

Potential residential edge conditions along natural heritage areas.

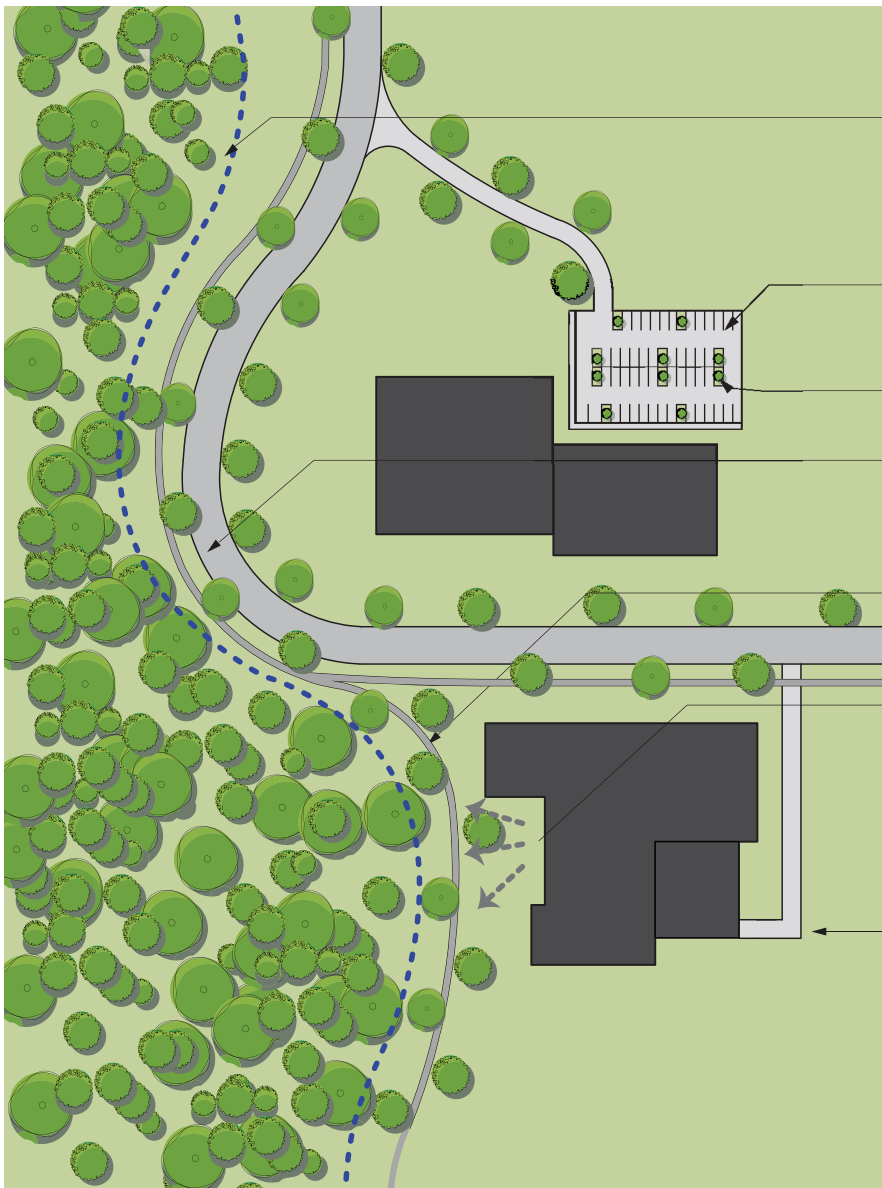

Natural heritage feature vegetation protection zones should be provided and protected where necessary

Parking adjacent to natural areas should include a sustainable stormwater management plan

Parking lots should include 1 tree for every 5 parking spaces

Streets can provide excellent buffers for natural areas and provide visual surveillance opportunities

Development adjacent to natural areas should include public and private walking and cycling trails

Building form and programming should recognize significant open spaces by ensuring active building areas with windows facing natural

Below grade parking is preferred

Development Adjacent to natural Heritage: public realm elements

Performance Standard No. 4.3.6 Development Adjacent to Agriculture

Agriculture plays an important role as an agricultural asset, wildlife corridor and transition zone between the urbanized areas. The interface between urban development and agriculture should consider the sensitivity of adjacent agricultural uses and protect for their longterm viability.

- a. Establish appropriate landscaped buffers between urban development and agricultural lands to minimize urban encroachment on agricultural lands and activities.
- b. Encourage landscaped buffers to be planted with native trees and shrubs. Planting should be low maintenance, salt tolerant and drought tolerant. Do not plant invasive species.
- c. Retain existing trees within buffers and ensure natural heritage features are not impacted within agricultural lands.
- d. Maintain and enhance views to and from agricultural lands.
- e. Consider the movements of wildlife through agricultural lands to the nearby Natural Heritage Network to provide corridors and connect natural spaces.
- f. Manage stormwater and groundwater to maintain pre-development flows on adjacent urban development sites so that agricultural lands are not impacted.
- g. Subject to approval by the appropriate authorities, integrate trails within the landscaped buffer to encourage connectivity between open spaces and development, where appropriate.

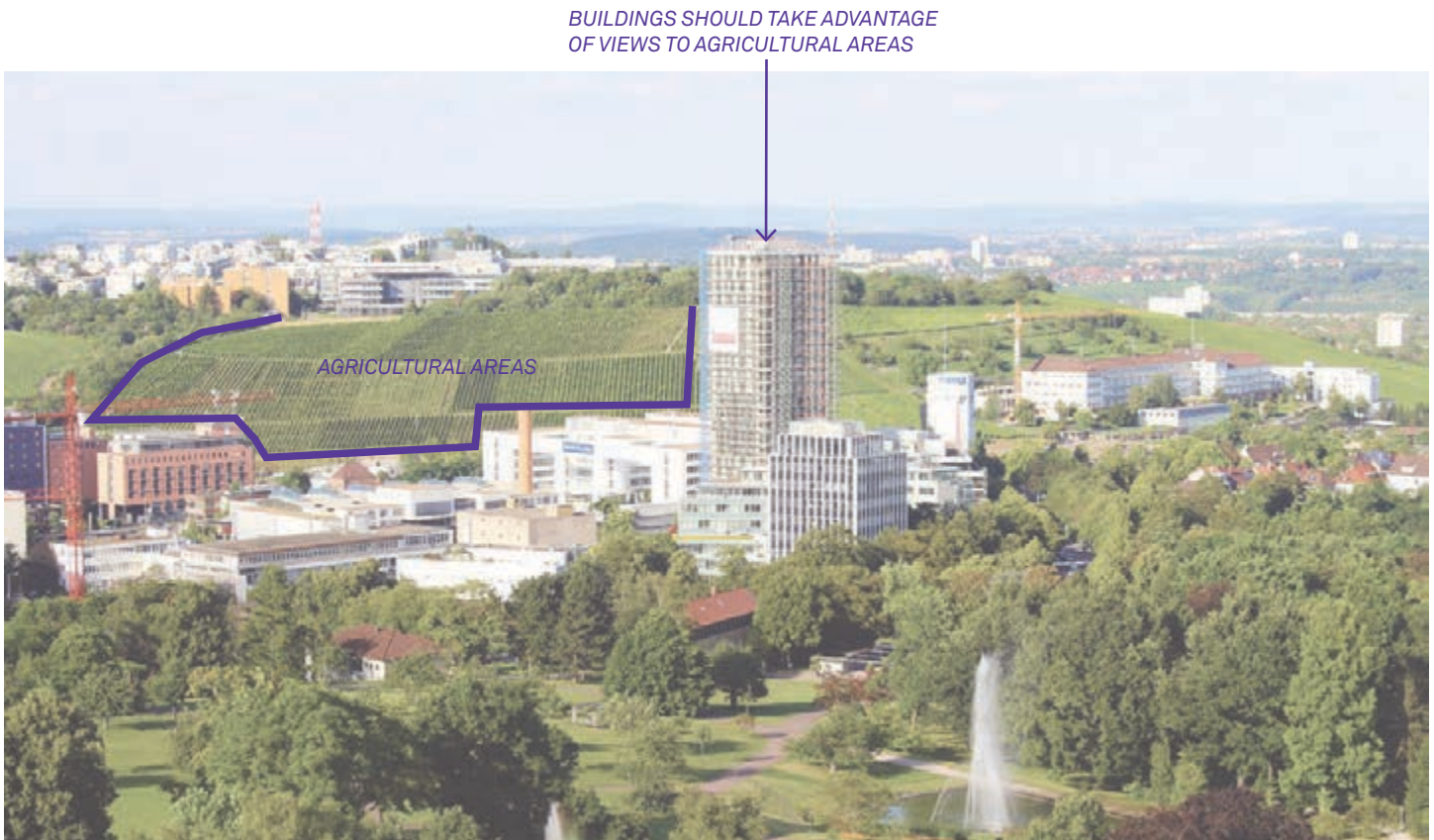

More robust buildings and landmarks should face rural areas to take advantage of views and vistas. Public open spaces should be co-located near naturalized and agricultural areas wherever possible. (Killesberg Park in Stuttgart. Image Credit: Pixabay)

Key guidelines:

- Performance Standard 4.3.3 Landmarks and Views
- Performance Standard 5.2.9 Grading and Drainage

Performance Standard No. 4.3.7 Development Adjacent to Cultural Heritage

Development sites within or adjacent to Heritage Conservation District resources or listed/Part IV heritage properties should consider and respond to the attributes and character of Heritage buildings and landscapes. Development adjacent to heritage buildings and landscapes should contribute to and enhance their existing heritage character.

- a. New development sites within Heritage Conservation Districts or designated heritage properties shall be consistent with the policies and guidelines contained within the respective Heritage Conservation District Plan.
- b. Proposed buildings within or adjacent to a Heritage Conservation District or designated heritage property shall respond to and be sympathetic to the design characteristics of heritage resources without reflecting those characteristics in a way that is inauthentic or anachronistic.
- c. Infill buildings shall consider:
 - » Incorporating a consistent front setback, or a recessed setback to highlight the heritage component, where appropriate.
 - » Incorporating a height-to-width ratio that is similar to existing heritage buildings.
 - » Retaining and highlighting important views of heritage resources.
 - » Establishing similar vertical or horizontal bays and storefronts, where appropriate.
 - » Using materials that complement adjacent heritage buildings.
 - » Maintaining lot shape and orientation.
- d. Where an infill building is developed adjacent to a heritage building with a continuous streetwall, the new building shall:
 - » Establish a base building that has a consistent height to the heritage building.
 - » Step back from the building face at or within one to two storeys of the height of the existing building.
 - » Match floor heights with the adjacent heritage building, or align horizontal elements to achieve consistency where contemporary commercial ground floor heights must be taller than heritage ground floor heights.
- e. Additions to listed or Part IV heritage properties shall respect the character, scale and form of existing heritage properties. Additions shall complement preserved portions of the building and should remain subordinate to the existing architecture.

FUTURE DEVELOPMENT SHOULD
RESPOND TO THE DATUM LINES OF
EXISTING BUILDINGS



A new building or addition next to a heritage building should reflect a similar floor-to-floor height and grade level building design.
(Shops of Summerhill. Image Credit: Urban Toronto)

Definition of Cultural Heritage:

- All individually designated properties (Buildings or structures designated under Part IV of the Ontario Heritage Act)
- All properties within a Heritage Conservation District (Buildings or structures designated under Part V of the Ontario Heritage Act)
- All properties in the Listing of Buildings of Architectural and Historical Value (The City of Vaughan's Register of Property of Cultural Heritage Value as per Part IV, Subsection 27 of the Ontario Heritage Act (approved by Council on June 27, 2005))
- All properties of interest to Cultural Services Division, including Cultural Heritage Landscapes, which is defined as "a defined geographical area of heritage significance which has been modified by human activities and is valued by a community" as per Vaughan OP.

Performance Standard No. 4.3.7 (Continued)

Development Adjacent to Cultural Heritage

Cultural Heritage Landscapes are areas that have been modified by people and assigned with particular cultural meaning. In Vaughan, these landscapes are intended to be preserved as publicly accessible spaces. Development adjacent to heritage landscapes shall preserve viewpoints, viewsheds and vistas to and from these landscapes.

- a. Clearly visible, public entrances to cultural heritage landscapes shall be preserved and enhanced.
- b. Planting adjacent to cultural heritage landscapes shall use native, non-invasive species that are known to the area.
- c. Site design and building placement adjacent to cultural heritage landscapes shall not disrupt significant existing or future view corridors.
- d. Landscaped buffers shall be provided between the proposed development and the cultural heritage landscape where a heritage impact assessment deems this form of preservation necessary.



James Dalziel Farmstead, Vaughan. (Image Credit: Google Earth)



Clearly visible public entrances to cultural heritage landscapes shall be preserved and enhanced. (Woodbridge Memorial Tower. Image Credit: Ontario War Memorials)

Key guidelines:

- Performance Standard 5.3.1 Buildings on Intensification Corridors
- Performance Standard 5.3.2 High-Rise Building Envelope
- Performance Standard 5.3.3 Mid-Rise Building Envelope
- Performance Standard 5.3.4 Low-Rise Building Envelope
- Performance Standard 5.3.6 Built Form Transitions
- Performance Standard 5.3.8 Thresholds and Entrances

Key policy reference:

- City of Vaughan Official Plan, Definition of Adjacent
- Vaughan OP, Chapter 6, Designated Heritage Properties and Cultural Heritage Landscapes

Performance Standard No. 4.3.8 Development Adjacent to Parkland

Development sites adjacent to a park should create an effective transition between public and private space while prioritizing public access to the park, providing eyes on the public space and protecting maximum sun exposure at key times of the day and year. This section of the Urban Design Guidelines should be read in conjunction with Official Plan Section 7.3.2 Parks and Open Space Design.

- a. Buildings should face parks with an active frontage, ensuring public access to public parks is prioritized.
 - b. Buildings fronting onto parks should provide a clear transition between public and private space through signage and landscape, while ensuring that public access to park spaces is prioritized. This may include a public street or pathway, or design cues like a low wall, shrubs or tree planting.
 - c. Buildings fronting onto a park should be oriented to address and frame park spaces, with primary entrances, front yards and significant glazing on the park-facing facade. Rear yard back-lotting is discouraged.
 - d. On sites larger than one regular block, direct connections to parks that are visible from public streets should be provided.
 - e. Parking should not be located between the park and adjacent buildings.
 - f. Buildings should be massed to maintain maximum sun exposure onto active park spaces, like playing fields and playgrounds.
 - g. Retaining walls and/or any other structures such as planters, fences and seating walls located within the proposed development block should be designed with a minimum setback from the edge of the property line to protect from future maintenance and replacement and to consider requirements for routine maintenance and operations such as snow clearing and mowing.
- Key Dimension:**
- h. Where multiple building access points are located along the park frontage, an active transportation pathway should be designed within a servicing access block (i.e. not considered parkland). The servicing access block shall address private access, lighting, landscaping, stormwater requirements, low impact development, or any other servicing required for the development block and shall be designed in consultation with Engineering and Operations. The width of the servicing access block shall be a minimum of six metres wide and the pathway designed within this block shall be a minimum of two metres wide. The design of the pathway within the servicing access block may vary from site to site to adequately respond to the design context.

LOW ORNAMENTAL WALLS HELP DISTINGUISH THE TRANSITION BETWEEN PUBLIC AND SEMI-PRIVATE AREAS



Townhomes face onto a Privately Owned Publicly Accessible Spaces. A transition between a park and a building may include a low wall or grade change. (35 Fieldway Rd, Etobicoke. Image Credit: City of Toronto)

PATHWAY PROVIDES ACCESS BETWEEN PRIVATE DEVELOPMENT AND PARKLAND



Private developments should provide sidewalk access adjacent to parkland.

Key guideline:

- Performance Standard 5.2.12 Pedestrian and Cycling Connections and Street Furnishings

Performance Standard No. 4.3.9 Development Adjacent to Employment and/or Highways

Employment lands are a valued part of the City's economic ecosystem. They should be protected and preserved, which requires, in many cases, that compatible uses and appropriate setbacks are required adjacent to these lands. Similarly, development adjacent to highways should be compatible in order to avoid issues with noise and environmental pollution.

- a. Adjacent development should not impact the longterm feasibility of employment lands. Appropriate setbacks, sound buffering and screening should be considered for any development adjacent to employment uses.
- b. Adjacent development should not prevent access to the appropriate infrastructure necessary for servicing employment lands.
- c. Noise attenuation measures, including noise walls and berms, must be developed in coordination with development adjacent to highways.
- d. Development adjacent to highways should maintain a strong visual character along these corridors. The visual character of employment uses along a highway can encourage a positive visual for the City. Alternatively, substantial landscaping and tree planting along highways can also promote a strong visual character.



Living sound barriers provide natural amenities and protect other land uses from sound pollution. (Living Wall and King's Cross London. Image Credit: Biotope)



Vegetative buffers leverage community amenities to protect sensitive uses. (West Toronto Railpath. Image Credit: Scott Torrance)

Key guidelines:

- Performance Standard 7.6.1 General Guidelines for Employment Buildings

Key policy reference:

- 2014 Provincial Policy Statement, 1.3.2.1

Section 5:
**SITE AND
BUILDING
PERFORMANCE
STANDARDS**

5.1 Introduction

Section 5 includes Performance Standards that address specific components of site and building design.

This section includes Performance Standards for:

- **Site Organization & Design:** Refers to the way that elements of the site area are laid out and their relationships to each other, as well as the design of each element of the site.
- **Building Design:** Refers to the design of all building components and elements. This section includes Performance Standards for building envelopes, which establish parameters within which building massing may take a flexible and creative form.

Performance Standards should be read in conjunction with Accessibility for Ontarians with Disabilities Act and Ontario Building Code Standards.

5.2 Site Organization & Design

Performance Standard No. 5.2.1 Building Location and Orientation

Buildings should be positioned to frame adjacent streets, open spaces and amenity areas while minimizing the visual impact of parking, servicing and loading areas. Buildings may also be set back to frame forecourts, courtyards, plazas and gardens, particularly in relation to public or institutional buildings.

- a. Buildings should generally be located to frame adjacent streets with direct access from public sidewalks. On corner sites, buildings should frame both streets.
- b. Buildings should also frame adjacent parks, natural heritage features, grade-related amenity spaces and other open spaces, providing building entrances onto these features.
- c. Where possible, taller building elements should be located at the south and southeast side of the site to reduce shadows cast on adjacent properties.
- d. Buildings should be located and oriented to take advantage of the environmental benefits of the site, to reduce heat gain, and to maximize natural light within the building.
- e. In general, where a site is adjacent to an area of lower-density development, taller building elements should be located further away with Mid-Rise buildings creating a transition in height.
- f. Buildings should be designed to reduce the visual impact of parking, by locating it underground, providing rear garages and reducing the visual dominance of integrated front garages. Where surface parking is provided, it should be located to the rear and side of buildings and be visually screened from the public realm.

Key Dimensions:

- g. A 3.5-10 metre front yard setback zone (7-10 metres on Intensification Corridors) allows for building projection and massing variation to provide architectural diversity while supporting the Green Approach.
- h. Building location and orientation should maintain 5 hours of consecutive sunlight on one side of the street.
- i. Front yard setbacks greater than 10 metres should be designed for building forecourts, courtyards and gardens, and not for surface parking.



*A corner building framing streets on both primary frontages.
(Image Credit: Richardson Affordable Apartments, David Baker + Partners, photo by Bruce Damonte)*



*Buildings framing an internal courtyard and amenity spaces.
(Image Credit: Brook McIlroy)*

Key guidelines:

- Performance Standard 5.2.2 Micro-Climate and Sky View
- Performance Standards 5.2.3-5 Parking
- Performance Standard 5.3.6 Built Form Transitions
- Performance Standard 6.1.1 The Green Approach
- Performance Standard 6.2.5 Urban Squares
- Performance Standard 6.2.6 Gardens

Performance Standard No. 5.2.2 Micro-Climate and Sky View

The micro-climate created by a building within its context should be considered to ensure that buildings have a balanced impact on wind, sunlight, views, noise and air quality. A balance should be created between elements of the micro-climate, such as reducing wind but improving natural ventilation, improving energy efficiency while reducing winter snow and ice build-up, and promoting passive heating in winter and cooling in summer.

Climate Responsive Design:

- a. A review of micro-climate conditions should be completed as part of site and building design for Mid-Rise and High-Rise buildings. It should consider where and when the sun hits, amount of rainfall, natural water levels, soil types, wind, potential for snow and ice buildup, and exposure to sound and light pollution.
- b. Orient buildings, outdoor spaces and entrances to maximize sun exposure and passive heating during cool months and to provide shaded areas during warm months. A south-facing orientation that allows winter solar gains is appropriate, provided that it is well-shaded during summer. Deciduous trees and outdoor shade structures will help to provide cool areas during the summer while maximizing sun exposure during the winter.
- c. Locate outdoor seating and amenity areas away from mechanical equipment or areas of noise.
- d. Minimize paved surfaces, using permeable materials, and increasing the amount of landscaped surface will enhance the potential for evapo-transpiration.
- e. Utilize paving, building and roof materials that will reduce heat storage and glare.
- f. Utilize paving materials with a high sound absorption coefficient in busy areas.
- g. Utilize green walls and roofs to reduce sound through absorption, cool the air through evapo-transpiration, provide shade and improve air quality.
- h. Within site plans, integrate both small green spaces to provide cooling islands during the day as well as larger green spaces to provide cooling islands at night.
- i. The effect of materiality on the building envelope's energy performance should be considered in the building's design.
- j. Incorporate weather protection such as canopies, cantilevers and overhangs at major building entrances.
- k. Consider how snow and ice will build up on mechanical equipment, clerestory windows, skylights, awnings, canopies, roof elements, screen walls and parapet walls to ensure that the danger of falling ice and snow is mitigated.
- l. Evolving building design and new materials (like vegetation or cool roofs, more energy efficient building envelopes, etc) can affect snow and ice melt. A review of winter performance should recognize these changes.
- m. Utilize solar shading devices, high-performance wall assemblies and glazing products to reduce long-term building heating and cooling requirements. Consider window and building orientation when designing and installing these features.



Building articulation helps to address downdrafts and other wind impacts on the pedestrian environment. (Image Credit: Brook McIlroy)



Small green spaces can provide cooling islands, improve air quality and reduce noise. (Image Credit: Brook McIlroy)

Key guidelines:

- Performance Standard 5.3.6 Built Form Transitions
- Performance Standard 5.3.9 Facade Design & Materials

Key policy reference:

- Urban Design Guidelines Technical Volume 2: Terms of Reference for Sun/Shadow Studies
- City of Vaughan Official Plan, Chapter 1
- Technical Volume 2 Terms of Reference, Wind Studies

Performance Standard No. 5.2.2 (Continued)

Micro-Climate and Sky View

- n. Building rooftops should be designed to be solar ready, where possible.

Wind Mitigation:

- o. Design buildings with articulation, stepping, canopies, arcades and landscape to reduce wind effects at the pedestrian level and in public spaces or POPS, both for walking and sitting, and to maximize sunlight in private and public open spaces.
- p. When locating building entrances, consider dominant winter winds and the potential for snow infiltration. Placement and detailing of canopies, wing-walls and wind screens can provide protection for entrances.
- q. Consider the size and shape of outdoor spaces, and orientation relative to wind flows. Locate them away from busy roads as these areas can trap air pollutants and noise.
- r. Where new streets are created, consider orienting streets obliquely to the predominant wind direction.
- s. Vegetation should be located on the southwest side of an open space to block wind and provide shading during the summer months.
- t. Projected overhangs, canopies or setbacks should be integrated into the building design to protect

pedestrians from negative wind impacts.

Shadows and Sky View:

- u. Minimize shadows cast on adjacent properties, public spaces and sidewalks through transitions and building massing. Shadow studies for Mid-Rise and High-Rise buildings should demonstrate that a minimum of 5 hours of sunlight is maintained on adjacent sidewalks. Mid- and High-Rise buildings should incorporate angular planes as described in 5.3.6 to maximize sunlight.
- v. Consider building heights relative to neighbours, spacing between towers and lower level design features to maximize sky view while reducing downdrafts.

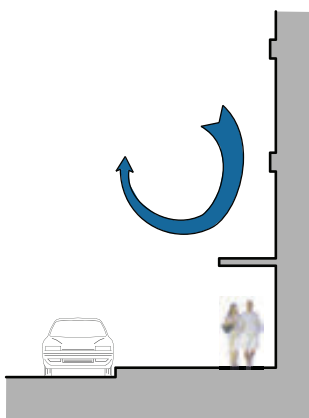

CANOPY

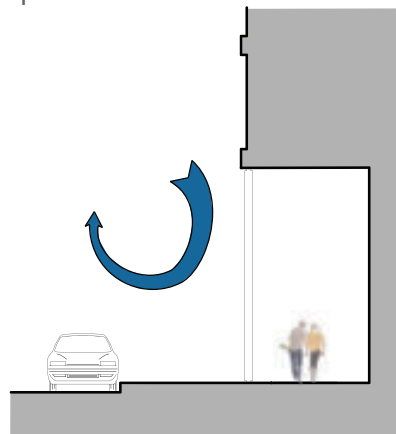

OVERHANG

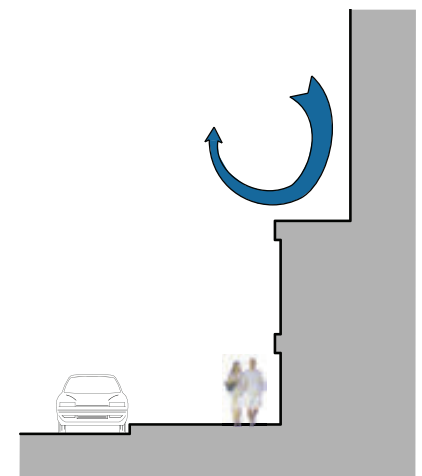

SETBACK

SPACING BETWEEN TOWERS
INCREASES ACCESS TO
SUNLIGHT AND SKY VIEW

LOWER HEIGHT PODIUMS
CAN HELP TO REDUCE
DOWNDRAFTS



Adequate spacing between towers and building articulation, like lower-height podiums, can help to reduce downdrafts. (Image Credit: Brook McIlroy).

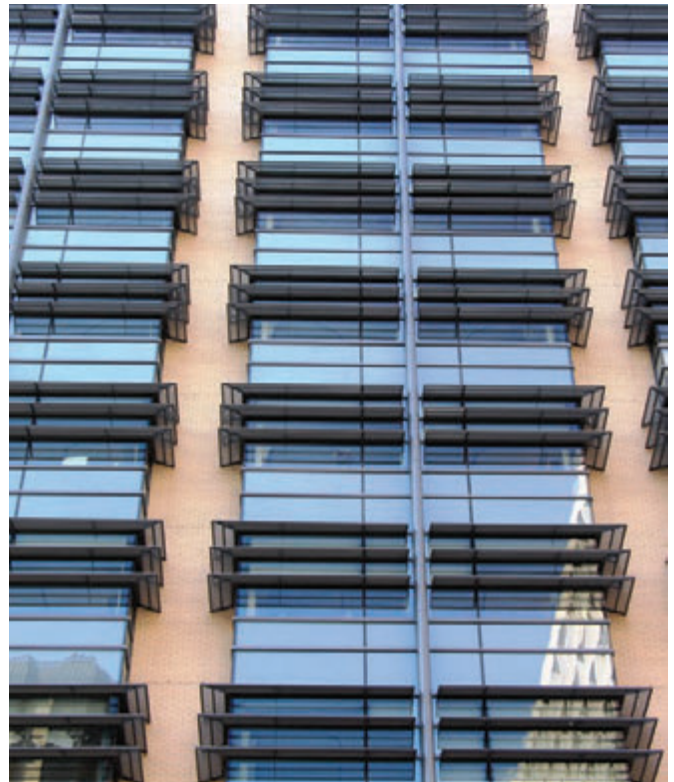

On south facing windows, solar shading devices can reduce heat gain and glare in the summer while allowing sun to enter in winter. (Image Credit: Brook McIlroy).

Performance Standard No. 5.2.3

Surface Parking

Surface parking is often necessary in interim redevelopment scenarios or where land values do not necessitate below-grade or structured parking in non-intensification areas. Overall surface parking should be designed to reduce its overall visual appearance through proper location and landscape. The performance standards for parking are general, and best practices depending on land use should also be considered.

- a. Where possible, shared parking and shared driveways between adjacent properties are encouraged. Easements may be necessary to achieve the design of shared driveways.
- b. Where surface parking is located next to a property line, it should be screened by a landscaped buffer and set back a minimum of 3 metres.
- c. Surface parking should not be located between a public road and the front or side yard of an Institutional, Low-Rise, Mid-Rise or High-Rise building. If surface parking is located between a public road and the front or side yard of an Employment/Industrial building, it should occupy no more than 50% of the frontage and contain no more than one parking aisle.
- d. Grading and landscape should be designed as part of the site's stormwater management plan to facilitate L.I.D. measures at the edges or within parking areas.
- e. Permeable paving may be utilized to minimize stormwater run-off where regular maintenance is guaranteed.
- f. Landscape should not obstruct sight lines for vehicles or pedestrians as per the City of Vaughan Crime Prevention through Environmental Design (CPTED) standards.
- g. Pedestrian-scaled lighting should be provided along pathways to parking areas.
- h. Preferential parking (i.e. accessible parking stalls, bicycles, car-share, energy efficient vehicles) should be located close to building entrances.
- i. Well-drained snow storage areas should be provided. These areas should be a minimum of 1.5 by 2.6 metres. They should be located away from public streets and major site lines, ideally within overflow parking or bio-retention areas. If this is not possible, snow should be removed off-site.
- j. Islands with shade trees should be provided at the end of a right of way.
- k. Plant species shall be salt tolerant.
- l. Parking rows should have a maximum of 20-25 continuous spaces.
- m. Parking aisles should be perpendicular to major destinations to minimize pedestrian crossing aisles.
- n. Active transportation crossings should be clearly marked.
- o. Surface parking for High-Rise and Mid-Rise buildings should be designed to be phased out over time.



Surface parking diagram with recommended landscape features.

Performance Standard No. 5.2.3 (continued)

Surface Parking

- p. Surface parking design should future-proof for the potential installation of solar PV canopies and/or electric vehicle charging stations. The accommodation of pick-up/drop off areas for TNCs and autonomous vehicles should be considered.
- q. Parking lots should be screened from surrounding public streets, sidewalks, parks, and other public properties using berms, walls fences, plants, planters or similar means.
- r. Signage should be incorporated into site design.
- s. Adequate buffering and protection against run-off should be provided whenever surface parking is located adjacent to natural heritage features.
- t. Ultimately, the goal is that all parking, except limited convenience parking, will be located within structures and the overall need for parking is reduced through the provision of regular and reliable access to transit and active transportation.

Key Dimensions:

- u. Surface parking lots should be divided into smaller “parking courts” by landscaped islands with a minimum of two deciduous shade trees each and pedestrian pathways. Parking court size for two rows is preferred.
- v. Planting one tree for every five parking spaces is recommended. Trees can be clustered to facilitate snow clearing and increase ecological impact; however, trees throughout the lot provide shade for cars, pedestrians and paving.
- w. Trees planted in parking areas require access to a minimum of 30 cubic meters of good quality soil per tree, or 20 cubic metres when shared.
- x. Clear 2.0 metre (minimum) dedicated pedestrian routes buffered with a landscaped median on one side (3.0 metre minimum width to accommodate L.I.D. measures) should provide direct connections

from parking areas to building entrances.

- y. The light intensity at the property boundary should be 0.0 lux to prevent light spillage, glare, or light cast over adjacent residential properties and open space/natural heritage areas.

Bicycle Parking:

- z. Bike access to parking areas must be inviting, convenient and safe to encourage cycling.
 - aa. Bicycle parking areas should be co-located with elevators or entrances to ensure they are located along the path of travel.
 - ab. Bicycle parking can be provided in bike parking rooms or with external locking areas. Bike Parking is ideally located at grade and easily accessed from the street by residents.



A rain garden with trees supports stormwater management. (Image Credit: Brook McIlroy).

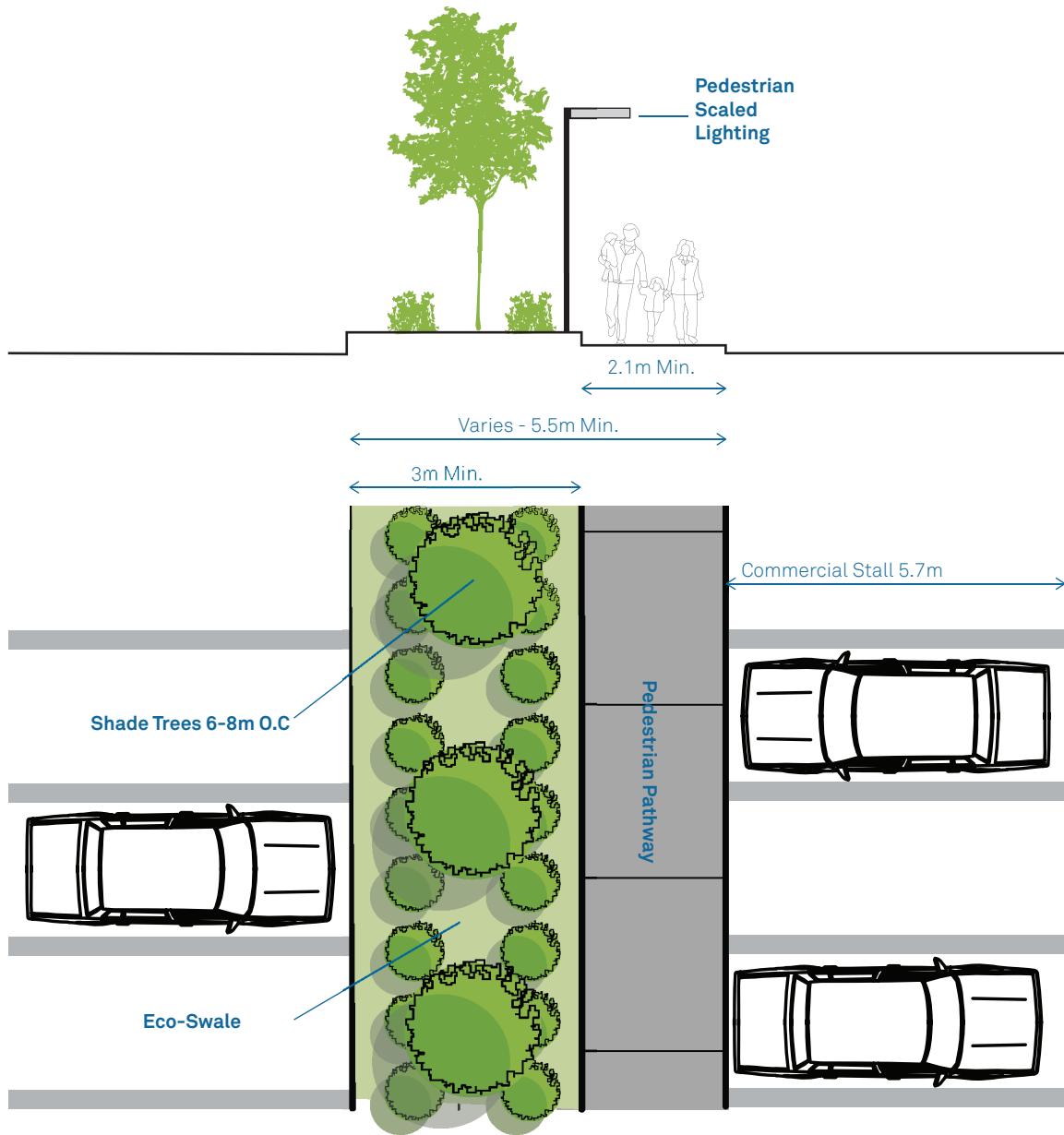

SECTION 5

Design concept for pedestrian pathway with one row of trees from the City of Vaughan Parking Design Guidelines.

Key guidelines:

- Performance Standard 5.2.12 Pedestrian and Cycling Connections and Street Furnishings
- Performance Standard 5.2.13 Site Signage and Wayfinding

Key policy references:

- City of Vaughan Official Plan, Chapters 4 and 9
- City of Vaughan Draft Parking Design Guidelines (Subject to approval by Council)

Performance Standard No. 5.2.4 Below-Grade Parking

Below-grade garages should be considered as the preferred option for parking, as a means of maximizing areas for building footprint, open spaces and landscape.

- a. Pedestrian entrances for parking structures should be located adjacent to main building entrances, public streets or other highly visible locations.
- b. Vehicular access to parking structures should be located at the rear and/or side of buildings away from main building frontages and major streets.
- c. Where access must be provided from the primary frontage, access to underground parking should be integrated into overall building design.
- d. Below-grade parking structures should be set back from property lines where possible to allow for uninterrupted mature tree growth that will not be affected by maintenance of the structure over time.
- e. Below grade parking design should utilize appropriate fonts and colours to provide clear wayfinding and signage that differentiate between public and private entrances, and should indicate pedestrian entrances and exits.
- f. Opportunities for water re-use and de-watering should be considered as permitted by building code.
- g. Parking garage entrance should include design treatments for safe access by cyclists to secure long-term bike parking and storage units, including pavement markings and signage.

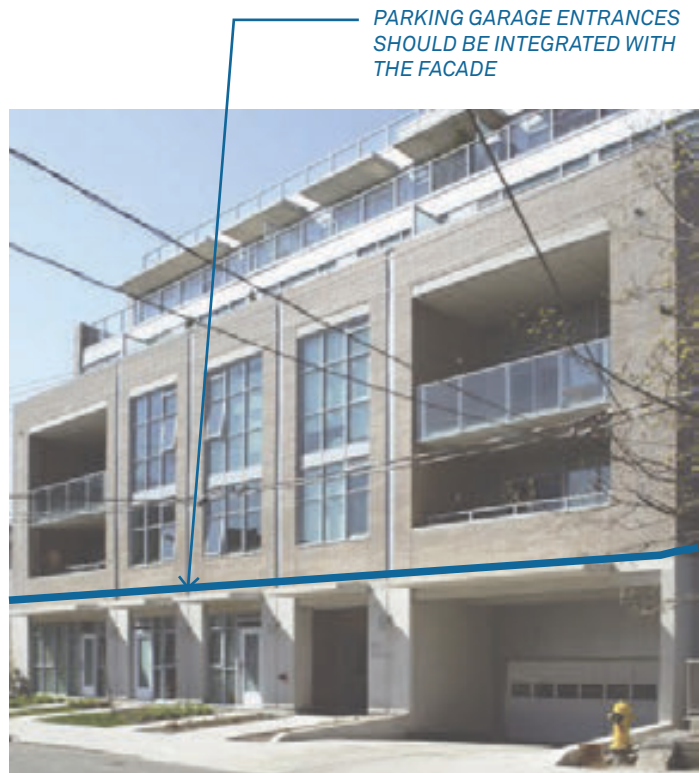

Access to underground parking is integrated into overall building design where it is provided from the primary frontage. (Image Credit: Brook McIlroy)

Key Dimension:

- h. Where trees and vegetation are planted above parking structures, a minimum depth of 1.2 metres of soil above the structure should be provided to allow for sufficient depth for soil cells and paving.

Key guidelines:

- Performance Standard 5.3.1 Buildings on Intensification Corridors
- Performance Standards 5.3.2-4 Building Envelope
- Performance Standard 6.1.2 The Green Approach on Intensification Corridors
- Performance Standard 6.2.2 Private Grade-Related Amenity spaces + Courtyards

Key policy references:

- City of Vaughan Official Plan, Chapter 4
- City of Vaughan Parking Design Guidelines

Performance Standard No. 5.2.5 Above-Grade Structured Parking

Parking garages that face onto public sidewalks should be designed to integrate into the surrounding streetscape. The lower levels should be wrapped with active uses. Stand-alone parking structures are not permitted.

- a. In mixed-use contexts, parking structures should be wrapped with active, at-grade uses facing public sidewalks, parks and open spaces to provide attractive, animated façades which contribute to the streetscape and enhance pedestrian safety.
- b. Vehicular access to parking structures should be provided from the rear of the building wherever possible.
- c. Pedestrian entrances for parking structures should be located adjacent to main building entrances, public streets or other highly visible locations.
- d. Where above ground structured parking garages are built next to public streets, they should be designed to contribute to the quality of the street with high quality screening that is durable and appealing.
- e. Where there is no at grade active use, the ground floor should be treated with architectural/landscaped screens to hide cars from view. Screens should use materials that are sensitive to the context.
- f. The design of above-grade structured parking should appear as a well-articulated and fenestrated building, and should consider adaptability and reuse in the case of future land use conversions.
- g. Parking garage entrances should include design treatments for safe access by cyclists to secure long-term bike parking and storage units, including

ARTICULATED UPPER FLOORS AND ACTIVE GROUND FLOOR ARE REQUIRED FOR ALL PARKING STRUCTURES



Parking structure wrapped with commercial uses at the ground floor. (Image Credit: Belmar Theatre by Elkus Manfredi, Lakewood, CO. Photo by Chris Whitis courtesy of SitePhocus.com)

pavement markings and signage.

Key Dimension:

- h. The ground floor height of parking structures should be a minimum of 4.5 metres floor to floor to match adjacent development and to accommodate retail units.

Key guidelines:

- Performance Standard 5.3.1 Buildings on Intensification Corridors
- Performance Standards 5.3.2-4 Building Envelope

Key policy references:

- City of Vaughan Official Plan, Chapter 4
- City of Vaughan Parking Design Guidelines

Performance Standard No. 5.2.6

Servicing, Storage Areas and Loading

Servicing, storage and loading are necessary components of all building sites. These areas need to be functional and easily accessible, and their visual impact should be minimized through location and screening.

- a. Loading docks, storage areas and service areas should be coordinated, consolidated and located together.
- b. Loading, servicing and storage shall be integrated within the building envelope where possible, and is not permitted outside between a building and the street.
- c. Where this is not possible, or where the lot frontage is less than 45 metres and is not a through lot, loading should be located at the rear of buildings and screened from public view while remaining accessible for use.
- d. To minimize the visual appearance of loading areas, loading can be located anywhere on a through lot except between a building and the Highway or an Arterial Road.
- e. Screening material should complement the design and treatment of the main building. Wood enclosures are discouraged.
- f. Dedicated screened storage areas for waste bins should be integrated into building and site design.
- g. Access to servicing and loading areas should be provided from secondary streets or rear laneways. It should include design treatments to minimize impact and improve safety for pedestrians and cyclists crossing these areas.
- h. Shared access is encouraged to minimize curb cuts.
- i. Loading, servicing and storage areas must not encroach into the exterior side or front yard setback.
- j. In Employment Areas, loading and service areas may occupy the full rear yard if a landscaped edge and/or buffer treatment is provided.
- k. Ensure that waste collection vehicles have ample room to maneuver at the site planning stage to ensure that these functions do not spill over into either the public right-of-way or public spaces.
- l. Molok System screening should not be required as the majority of garbage should be stored below grade.
- m. Molok Systems, if used, should be located in areas that are easily emptied and meet the manufactured maintenance and emptying requirements. Larger format systems should not be located in prominent areas and should be screened similarly to typical loading and storage areas. Molok systems should be screened like loading, servicing and storage areas.

SERVICING AND LOADING AREAS ARE TO BE AT THE BACK OF BUILDINGS



Access to servicing and loading area at the rear of the building. (Image Credit: Brook McIlroy)

HIDDEN WASTE BIN STORAGE AREAS



An enclosure for waste bins is integrated into the Townhouse design. (Image Credit: Brook McIlroy)

Key guidelines:

- Performance Standard 5.2.10 Screening, Fencing and Low Walls
- Building Use Performance Standards (7.2-7.5)

Key policy references:

- Zoning By-law 1-88 Section 3.9 “Loading Space Requirements”

Performance Standard No. 5.2.7

Private Roads

Private roads are typically found internal to development blocks, and provide frontage to internal buildings as well as an enhanced driveway experience.

- a. Private roads should only be considered if the City has determined that the road provides no connective value to the surrounding community or future adjacent redevelopment sites.
- b. Private roads should be designed as complete streets that safely accommodate all modes of traffic, include features that slow vehicular traffic, and have a strong design focus on pedestrian and cyclist movement.
- c. Private roads should connect to main roads at transit stops to facilitate pedestrian access.
- d. Street trees should line private roads on at least one side with a minimum spacing of 10 metres between trees (as below grade services permit). Street trees should be located within a minimum 2.5 m continuous landscape strip or tree trench to ensure 30 cubic metre soil volumes for long-term tree health.
- e. Sidewalks should be provided on the side of the private road where building entrances are present. Sidewalks should be provided on two sides if more than 40 units are facing the road or if the road connects to major destinations such as parks or schools.
- f. On-street parking on private roads should be considered to provide informal visitor parking and to provide street friction to slow traffic.
- g. Alternative paving materials that allow for storm water to naturally infiltrate should be considered.

Key Dimension:

- h. The private ROW should be 8 metres to accommodate emergency vehicles.
- i. Sidewalks should have a minimum width of 2 metres.

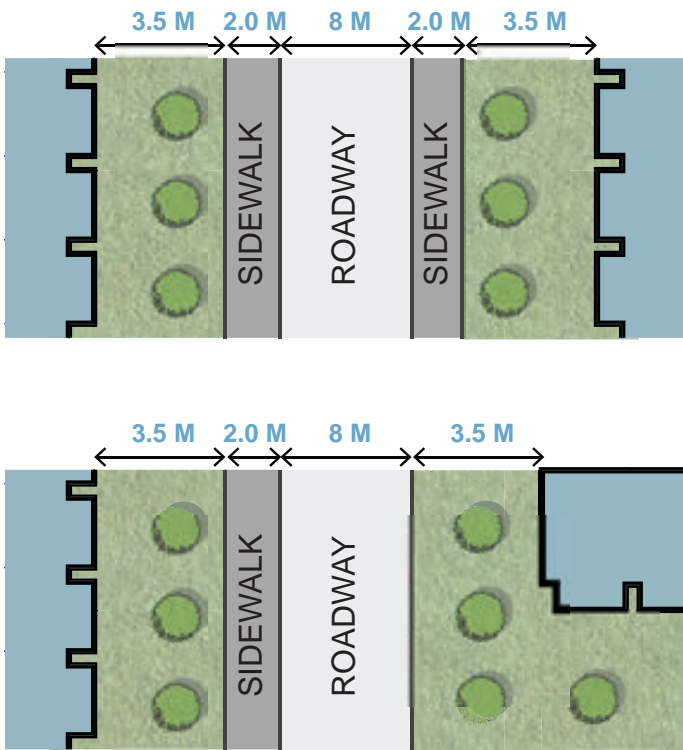

Sidewalks should be provided on at least one side of the private road to connect pedestrians to building entrances.

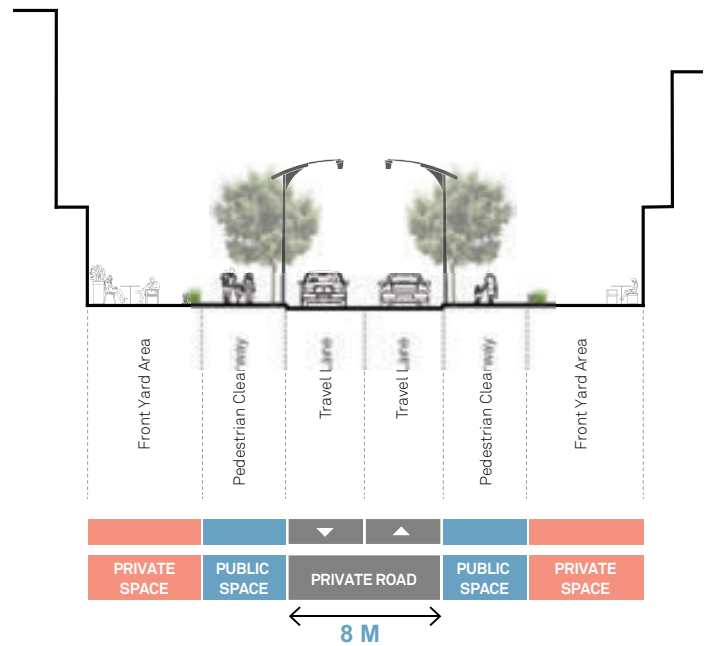

SECTION 5

Sidewalks should be provided on two sides if more than 40 units are facing the road.

Performance Standard No. 5.2.8

Driveways and Laneways

Laneways and driveways provide access to parking, servicing and loading functions that are located away from the primary public street. These are highly functional spaces with many uses. They should be designed to accommodate a safe environment as well as the functional, informal and social needs of the residents.

Driveways

- a. Driveways onto public streets should be consolidated to maximize potential tree planting and landscaped zones along the street, to reduce interruptions in the pedestrian realm and reduce the width of paved surfaces.
- b. Driveways to townhouse units should be paired to create wider landscaped areas between driveways.
- c. Pedestrian facilities should be continuous across all driveway and laneway entrances.

Key Dimension:

- d. For residential uses with integrated front garages, individual driveway widths should not exceed 3.0 metres for single car garages and 6.0 metres for double car garages (where permitted).

Laneways

- e. Laneways can be used to service commercial and townhouse uses, where front-yard garages/ parking are undesirable and to provide access to parking, garbage pick-up and loading areas.
- f. Primary building facades should not face laneways, nor should primary at-grade access to buildings be provided from laneways.
- g. Areas at the end, or beside, laneways should be reserved for snow storage.
- h. The use of permeable materials is encouraged where sufficient drainage exists, as low traffic levels permit the use of less durable surfaces.
- i. Adequate lighting should be provided for safety.

Key Dimensions:

- j. Laneways should be a minimum of 6 metres in width and have a 1.2 metre pathway on one side. The pathways should not have a raised curb but should be denoted by a painted line or change in material and should connect to the adjacent sidewalk.
- k. To maintain adequate distance between the vehicular traffic on the laneway and the rear of the garage, a minimum setback of 0.6 metres should be provided between garages and laneways in residential areas.
- l. An additional setback with a minimum depth of 2.7 metres can be used to accommodate parallel parking along rear laneways.
- m. Laneway access should be provided at a central location where blocks exceed 250 metres.



Rear laneway providing access to garages. (Image Credit: Brook McIlroy).

Key guidelines:

- Building Use Performance Standards (7.2-7.5)

Key policy references:

- City of Vaughan Urban Design Guidelines for Infill Development in Established Low-Rise Residential Neighbourhoods

Performance Standard No. 5.2.9 Grading and Drainage

The proper grading of a site affects both its technical ability to effectively deal with stormwater and the visual character of the development. Both the technical and visual design should be well executed to ensure the development fits well on the site and in the community.

- a. Existing grade should be retained to the greatest extent possible.
- b. Site grading should manage stormwater and groundwater to maintain pre-development flows.
- c. Stormwater design should manage flow on-site to ensure that water will not discharge to the surrounding streets, adjacent properties or existing storm sewers.
- d. Sheer retaining walls facing the street are not recommended.
- e. Where retaining walls are required, they should be paired with landscape design to reduce the overall impact of the wall.
- f. Retaining walls can be designed as signage or landscape features within the site.
- g. The site must be graded to ensure that pedestrian site circulation conforms to Accessibility for Ontarians with Disabilities Act (AODA) standards.



Where retaining walls are used, they should be paired with landscape. (Image Credit: Liberty Village, Photo by Brook McIlroy)

Key guidelines:

- Performance Standard 5.2.2 Micro-Climate and Sky View
- Performance Standard 5.2.10 Screening, Fencing and Low Walls

Key policy references:

- City of Vaughan Official Plan, Chapters 4 and 10

Performance Standard No. 5.2.10 Screening, Fencing and Low Walls

Screening should be incorporated into the building design to provide a visual buffer for servicing or back-of-house uses from the public realm that improves the streetscape and pedestrian experience.

Fencing and low walls are landscape features that help define different site areas. Their use should be carefully considered and appropriate for the site.

- Fences and low walls can frame public pathways and open spaces, and can prevent unwanted foot traffic within planted or naturalized areas.
- Fences and walls should not create leftover or disconnected areas that are without program or purpose.
- The use of solid fences as visual buffers is generally discouraged.
- The character of the fence or low wall should be in keeping with the overall site and building design and should consider the typologies and locations of fences on adjacent properties.
- Unnecessary fencing that impedes circulation and mid-block connections is not permitted.
- Screening, fencing and low walls should be constructed of high quality materials.



A wooden screen provides visibility as well as a visual buffer to a grade-level parking garage. (Image Credit: Brook McIlroy)

- Chain link fencing along the public realm is not permitted.

Key guidelines:

- Performance Standard 4.3.4 Development Adjacent to Trails
- Performance Standard 4.3.5 Development Adjacent to Natural Heritage
- Performance Standard 4.3.8 Development Adjacent to Open Space
- Performance Standard 5.2.11 Mid-Block Connections/Mews

Performance Standard No. 5.2.11

Mid-Block Connections/Mews

Mid-block connections/mews are important threshold spaces. They provide finer-grain connectivity within a neighbourhood and should be designed to provide connections between buildings and to adjacent properties within a development block. These spaces typically do not include programmatic uses aside from a pedestrian, cyclist and/or vehicular connection with landscaped edges.

- a. Mid-block connections/mews should provide landscaped zones on each side that buffer the pathway from the adjacent buildings and uses as required.
- b. The pathway should not be contained between high solid fences. A low wall or fence may be appropriate between the mid-block connection and residential uses.
- c. Appropriate lighting and wayfinding signage should be incorporated.
- d. Mid-block connections/mews should connect to trails or sidewalks on either end and should include signage or provide other cues that it is a public connection. They should be barrier free and visible from the sidewalk.
- e. Vehicular connections that act as mid-block connections should be designed to appear public in character and must include a pedestrian sidewalk or trail and landscape. Mid-block connections/mews

usually have the same level hierarchy for all modes of transportation, functioning like flexible streets.

- f. Grade-level commercial building uses are encouraged to wrap around the building to address the mid-block connection. Spill-out spaces can be considered where appropriate.
- g. Blank walls fronting onto mews are discouraged. Active frontages should address the mid-block connection.
- h. To gain entry into significant public amenities, the City may require that mid-block connections and pedestrian mews meet requirements to become Privately Owned Publicly-Accessible Spaces . The City may also require a public access easement within private mid-block connections and pedestrian mews.

Key Dimensions:

- i. Mid-block connections/mews should be located centrally in blocks that are longer than 200 metres in length.
- j. Sidewalks and pedestrian pathways should be a minimum of 2.0 metres in width and should remain clear of snow and debris year-round.
- k. Multi-use trails used for both cycling and walking should be a minimum of 3.0 metres and remain clear of snow and debris year-round.

Key guidelines:

- [Performance Standard 4.3.1 Streets and Blocks](#)
- [Performance Standard 5.2.12 Pedestrian and Cycling Connections](#)
- [Performance Standard 5.3.7 Separation Distances](#)
- [Performance Standard 6.2.8 Privately Owned Publicly-Accessible Spaces \(POPS\)](#)

ACTIVE PROGRAMMED AREAS FRAMING A MID-BLOCK CONNECTION



Active uses may wrap around the building to address the mid-block connection. (Image Credit: Brook McIlroy)

LANDSCAPE AREAS FRAMING A MID-BLOCK CONNECTION



Mid-block connection with adjacent landscape and a pathway between groupings of townhouses. (Image Credit: Brook McIlroy)

SECTION 5

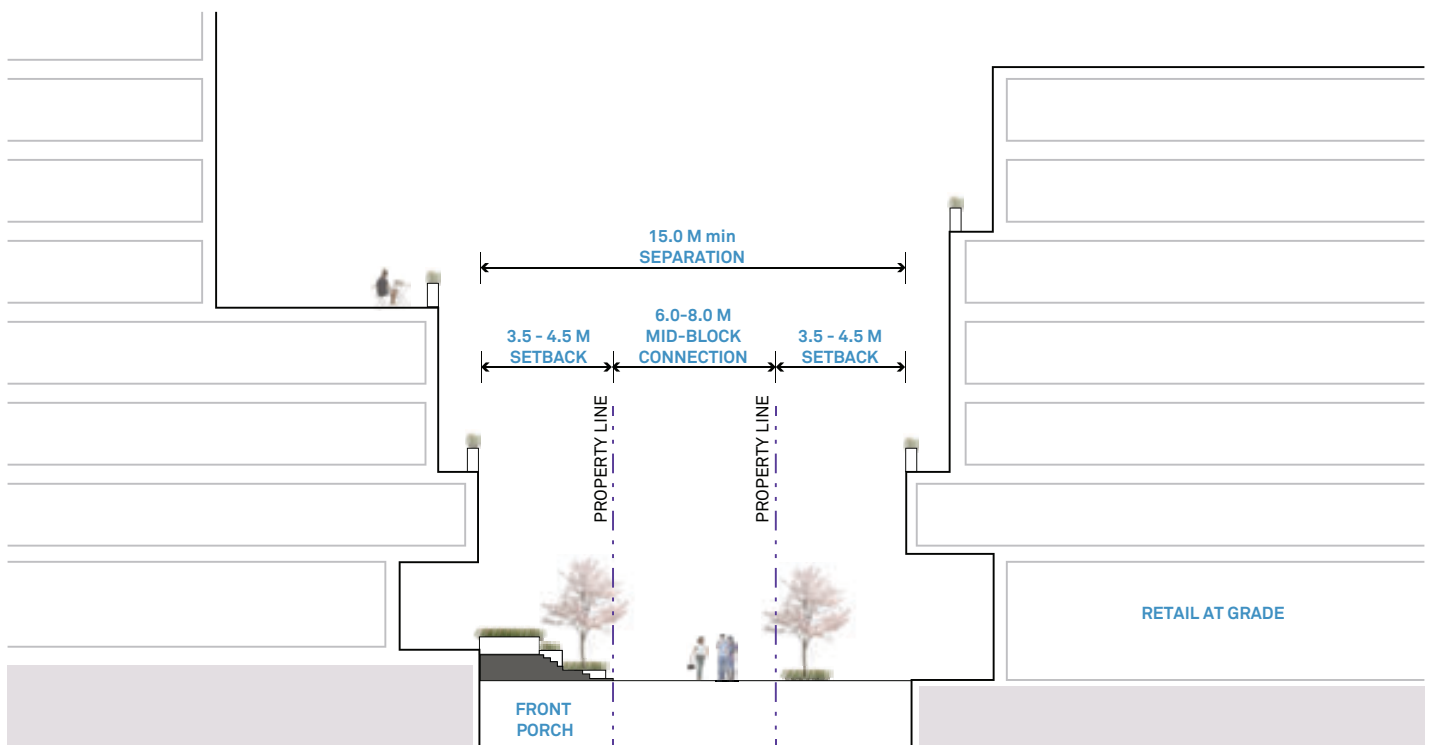

Pedestrian mews between buildings with active frontages and ground floor residential entrances. See Performance Standard 5.3.7 for separation distances between buildings above the 6th storey.

Performance Standard No.

5.2.12

Pedestrian and Cycling Connections and Street Furnishings

Accessible streets and cycling connections are key to reducing the City's dependence on driving. These connections should be co-ordinated with future development sites to ensure a fine-grain active circulation network between the public and private realm. Cycling connections should be demonstrated in a context plan for the site. These connections should be complemented by street furnishing that creates a comfortable and attractive public realm.

Pedestrian and Cycling Connections

- a. Large sites spanning more than one block should be bisected with pedestrian and cycling trails to connect to the larger urban fabric. (See 5.2.11)
- b. Weather protection like overhangs, canopies, colonnades or awnings may be appropriate to shelter pedestrian pathways alongside buildings.
- c. Trailheads should clearly demarcate the entrances to multi-use trails with adequate wayfinding and signage, space for gathering, and gateway features such as public art where appropriate.

Street Furnishings

- d. Cycling and pedestrian furnishings should be concentrated in areas with high pedestrian activity, in Privately Owned Publicly-Accessible Spaces and in amenity spaces.
- e. Complementary furnishings like benches, pedestrian lighting and waste receptacles should be clustered.
- f. Provide furnishings and lighting near building entrances and along mid-block connections and other on-site pathways where appropriate.
- g. Furnishings should not obstruct pedestrian, vehicle or cyclist circulation and sight lines or hinder sidewalk / trail maintenance and snow removal.
- h. When installing sidewalk bicycle racks, maintain pedestrian through zones. Racks should be placed in line with existing sidewalk obstructions to maintain a clear line of travel for pedestrians.
- i. Short-term bike parking should be visible from and close to the entrance it serves. 15 metres or less is a good benchmark. Weather protected parking is recommended as it makes bicycle transportation more viable for daily and year-round use.
- j. Where multiple furnishings are provided, they should be selected from a consistent family or from the City's standard furnishings.
- k. Seating areas should be coordinated with tree planting to provide shade.
- l. Where raised planters are provided, they are recommended to be designed to double as seating areas incorporating IPE wood slats for all-season comfortable seating.



Bicycle racks provided near a sheltered building entrance. (Image Credit: Brook McIlroy)

- m. Where waste receptacles are provided, they should provide multiple streams to sort waste.

Key Dimensions:

- n. A bicycle parking space should be 2.0 metres long by 0.6 metres wide with a minimum vertical clearance from the ground of 1.9 metres. A minimum 1.0 metre clearance between the centre of the bike rack and the building is required.
- o. Street furniture should include the following clearances:
- » within 2 metres of the end of a corner radius;
 - » within 1 metre of a curb cut for seating;
 - » within 0.6 metres of a driveway;
 - » within 2 metres of a fire hydrant;
 - » within 1 metre of a traffic signal pole, utility pole or tree.

Key guidelines:

- Performance Standard 4.3.3 Development Adjacent to Trails
- Performance Standard 5.2.11 Mid-Block Connections/Mews
- Performance Standard 5.2.13 Site Signage and Wayfinding

Key policy references:

- City of Vaughan Official Plan , Chapters 1 and 4

Performance Standard No.

5.2.13

Site Signage and Wayfinding

Site signage and wayfinding should be clear and visible and should be consistent throughout larger sites. The scale of signage should be appropriately designed to match its intended users. Signage should be integrated with architecture to the greatest extent.

- a. Ground signage should not overwhelm the appearance of the streetscape nor restrict the placement or growth of street trees.
 - b. In areas with high pedestrian traffic, commercial signage should be pedestrian scaled.
 - c. Mobile signs are discouraged.
 - d. Back-lit box signs are prohibited.
 - e. Signage should not impede pedestrian circulation or vehicle sight lines.
 - f. Information or educational signage should be located in high traffic areas where there are unique site elements or characteristics to highlight, such as special landscapes, cultural heritage features, etc.
 - g. On large sites, a hierarchy of signage should be implemented uniformly to create a distinct identity for the site. Signage should encompass wayfinding and directional signage, information signage and commercial signage. A coordinated approach will reduce the overall amount of signage, while ensuring that wayfinding signage is highly visible and easy to understand.
 - h. Advertising signage should not be included within street furniture with the exception of small, unobtrusive plaques to indicate the source of funding for the furniture, if applicable.
 - i. The scale, visibility and design of signage should respond to and fit within the surrounding context and the long term character of an urban area. Pylon signage is discouraged in urban conditions, particularly in urban pedestrian areas. Street signs, road signage, and advertising signs, for example should be designed for optimal visibility by pedestrians to be viewed at the speed of pedestrian traffic. Signage that is optimized for pedestrians does not need to be as large as signage that is optimized for vehicular traffic.
- Key Dimensions:**
- j. The face area of electronic ground signs should not exceed 0.7 square metres.
 - k. On multi-tenant commercial sites, limit the number of commercial signs to one sign per business per elevation.



Commercial signage should be pedestrian scaled in areas with high pedestrian traffic. The visibility and design of signage should fit

within the surrounding context. (Image Credit: La Cantera Flora and Fauna inspired wayfinding by Fd2s Design Consultants, San Antonio, Texas)



A coordinated approach to wayfinding will reduce the overall amount of signage. (Image Credit: Fd2s Design Consultants)

Key policy references:

- City of Vaughan Sign By-law

Performance Standard No.

5.2.14

Public Art

Public art can enhance the unique culture and history of the City and the site. Its design should be place-specific and should explore opportunities to celebrate historic and cultural events or to complement building and site design. Public art can be free-standing or integrated into the site's architecture.

- a. Public art should be displayed in exterior public spaces and should be accessible 24 hours a day, or throughout the site's hours of operations for settings such as parks, community centres and public plazas.
- b. Significant public art pieces should be the subject of design competitions to support local artists and to promote excellence and innovation.
- c. Public art should be place-specific and should be located at key destinations within the City.
- d. Public art is encouraged within private developments that have significant public spaces (i.e. courtyards, lobbies, forecourts, plazas, etc).
- e. Public art should be visually and physically accessible.
- f. Public art should be durable and low-maintenance and should be complemented by adjacent landscape where appropriate.
- g. Sites may be reserved for groupings of complementary pieces, including temporary installations.
- h. Consider public art that is interactive or integrated as part of site furnishings or other infrastructure.
- i. Consider temporary installations as well as permanent pieces.
- j. The City Wide Public Art Program should be consulted for guidance on study process, feedback, policy framework, commissioning methods and implementation.



Public art designed to incorporate landscape features. (Image Credit: Galindez Slope by ACXT)



Public art designed to complement an adjacent high-rise building at a prominent corner. (Image Credit: Brook McIlroy)

Key guideline:

- Performance Standard 4.3.3 Landmarks and Views

Key policy reference:

- Vaughan City Wide Public Art Program

Performance Standard No. 5.2.15 Site Lighting

The design and location of lighting should consider sustainability, safety and the impacts of light pollution.

- a. All pedestrian and streetscape lighting should be “dark sky” friendly to minimize light pollution.
- b. Private property lighting should ensure safe and well-lit pedestrian areas, including parking areas and building entrances. Lighting may also be located within key landscape areas or along trails, but only where evening use is encouraged.
- c. Light fixtures should be selected in accordance with existing City engineering standards and should consider all maintenance ramifications.
- d. In key areas, lighting can be used to accent special features, such as building features, heritage properties, landscape and signage.
- e. The design and location of lighting should consider sustainability and the impacts of light pollution including: energy efficiency, induction lighting, solar power and street reflectors and sensors (to help regulate brightness and when lights turn on and off).
- f. Consideration should be given to providing additional pedestrian-scale lighting in areas with a high volume of pedestrian and cyclist activity, such as key intersections, transit stops, trail crossings, and mid-block connections.
- g. Where possible, lighting should be integrated into the building design.
- h. In efforts to save energy and create a comfortable and pedestrian-friendly boulevard, photometric calculations should consider the ambient lighting from adjacent buildings.



Site lighting along a pedestrian pathway. (Image Credit: Brook McIlroy)

Key Dimensions:

- i. Barrier-free pathways should be lit at a minimum level of 5 lux.

Key guidelines:

- Performance Standard 5.2.11 Mid-Block Connections/Mews
- Performance Standard 5.2.12 Pedestrian and Cycling Connections and Street Furnishings

Key policy reference:

- Site Plan Accessibility Impacts Checklist

Performance Standard No. 5.2.16 Utilities

Utilities must be considered as an integral component of site and building design to reduce their visual impact on the public realm.

- a. Context analysis should illustrate the constraints for below- and above-grade utilities in advance of site plan design to ensure that utilities do not become a predominant site characteristic.
- b. Utilities should be placed within the street right-of-way (or in a front yard easement) in a joint utility trench that can be accessed for repairs without disturbing street or site trees.
- c. Utilities should be integrated into building design, placed in discreet locations away from the primary building frontage and amenity spaces and/or screened from public view.
- d. Where utilities cannot be located below-grade, they should be clustered in a single location and appropriately screened subject to City approval.
- e. Screening materials should be high quality and complementary to building design.



Consolidated utilities should be screened from view. (Image Credit: Brook McIlroy)

Key guideline:

- Performance Standard 5.2.10 Screening, Fencing and Low Walls

5.3 Building Design

Performance Standard No. 5.3.1 Buildings on Intensification Corridors

Buildings on Intensification Corridors will promote the Vaughan Green Approach by creating a consistent landscaped area at the grade level, framed by buildings that are well-articulated, mitigate negative micro-climate effects, and promote design excellence and variety.

- a. The building face at the ground floor, which is the most critical to creating human-scaled and well-framed streets, will be set back from the front property line at the ground floor level (“pushed” and “lifted”). This extends the Green Approach and creates a generous space for additional landscape and programming to support the grade level uses.
- b. Within the front yard where the Green Approach zone is applied, projections are permitted on the ground floor to bring active building uses closer to the street, such as community facilities, lobbies, interior amenity spaces, and retail uses.

ENHANCED FRONT YARD SETBACK TO UNIFY STREET DESIGN AND CHARACTER



Front yard setbacks will provide a consistent landscaped area at the grade level in support of the Green Approach. (Quay West at Tip Top. Image Credit: Brook McIlroy)



Projections above the Green Approach zone enhance articulation of the building envelope while providing space for an enhanced landscaped setback. (Image Credit: Brook McIlroy)

- c. At higher levels, cantilevered building elements are permitted to project within the Green Approach, to a maximum width and depth.
- d. Buildings along Intensification Corridors should not incorporate surface parking, beyond small convenience parking areas for commercial or office uses. All parking should be provided in structures or underground.
- e. Intensification Corridors should promote enhanced permeability and connected circulation networks through the creation of new streets and blocks, cycling and pedestrian infrastructure and mid-block connections on blocks longer than 200 metres.
- f. This approach to building design on Intensification Corridors will apply in most situations. Exceptions may be made for contexts where there is an adjacent heritage resource, the presence of an existing continuous streetwall or a Secondary Plan or Heritage Conservation District Plan that supersedes this document.

Key guideline/policy references:

- Performance Standard 5.2.11 Mid-Block Connections/Mews
- Performance Standard 5.3.2-4 Building Envelope
- Performance Standard 6.1.1 The Green Approach on Intensification Corridor

Key policy references:

- City of Vaughan Official Plan, Chapter 2

Performance Standard No. 5.3.1 (continued) Buildings on Intensification Corridors

6 STEPS FOR BUILDING DESIGN ON INTENSIFICATION CORRIDORS

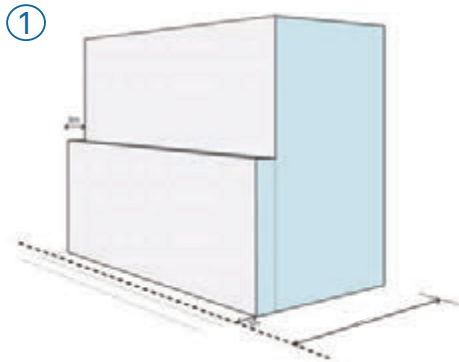

1. A maximum 6-storey podium

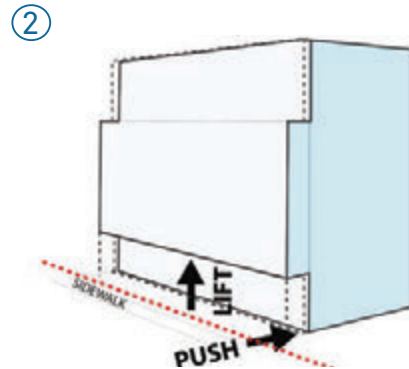

2. Flexible lower level design

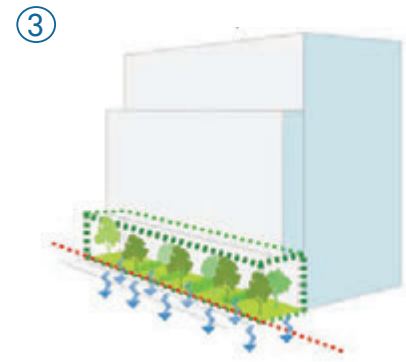

3. The Green Approach extends front yard landscape design.

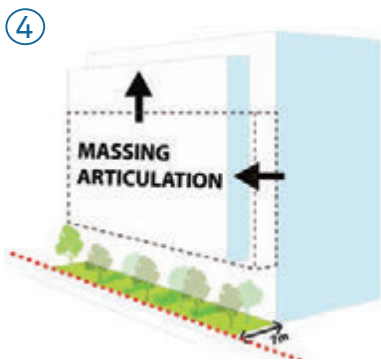

4. Flexible upper building level massing redirects the building bulk.

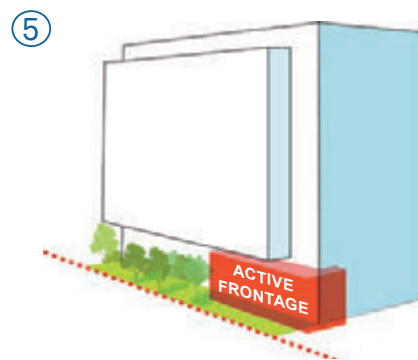

5. Front yard building projections enhance the Green Approach.



6. Flexible building design promotes architectural excellence and a green site setting.

KEY MAP SHOWING THE LOCATION OF THE GREEN DATUM ON INTENSIFICATION CORRIDORS

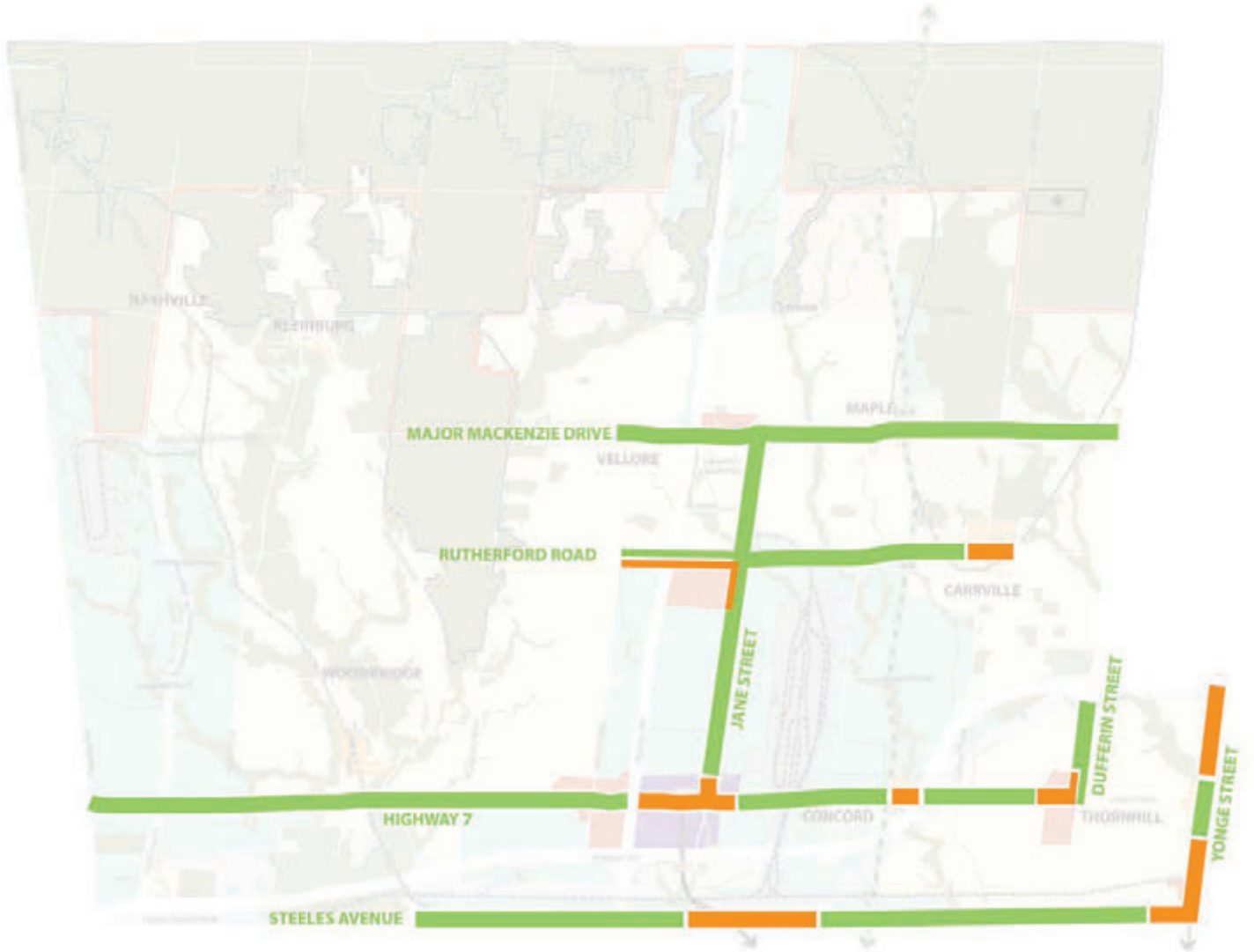

LEGEND

-  GREEN DATUM IN INTENSIFICATION AREAS
-  SECONDARY PLAN AREAS

Performance Standard No. 5.3.2 High-Rise Building Envelope

High-Rise buildings should contribute to the City's skyline with attractive and well-defined building components. Building shape and massing have potential to reduce building energy loads - a compact building shape versus long, narrow and tall buildings will achieve better building performance.

- a. High-Rise buildings are those above 12 storeys in height.
- b. Building massing should be an early design consideration as it accounts for passive solar gain, reduction in heating and cooling energy and other site-specific conditions.
- c. High-Rise buildings should have a compact form with a maximum floorplate size of 850 square metres for residential buildings. This will reduce energy loads and the negative impacts associated with shadows, views and privacy.
- d. The tops of High-Rise buildings should be shaped to contribute to an interesting skyline.
- e. High-Rise buildings should be designed to provide a positive micro-climate, such as reducing wind downdrafts and ensuring that shadows move quickly over the ground. In the absence of a podium, wind downdraft should be addressed with a strong standard for deep awnings and canopies.
- f. The High-Rise building base should be no longer than 80 metres in length. Longer buildings must be broken up by building components that are sufficiently set back or of different heights to visually appear as two separate buildings from grade.

Key guidelines:

- Building Design Performance Standards 5.3.6-5.3.14
- Performance Standard 6.1.1 The Green Approach
- Building Use Performance Standards (Sections 7.2-5 and 7.6)



High-Rise buildings should contribute to the City's skyline with attractive and well-defined building components. (Image Credit: Brook McIlroy)

Key policy reference:

- City of Vaughan Official Plan, Chapters 5 and 9

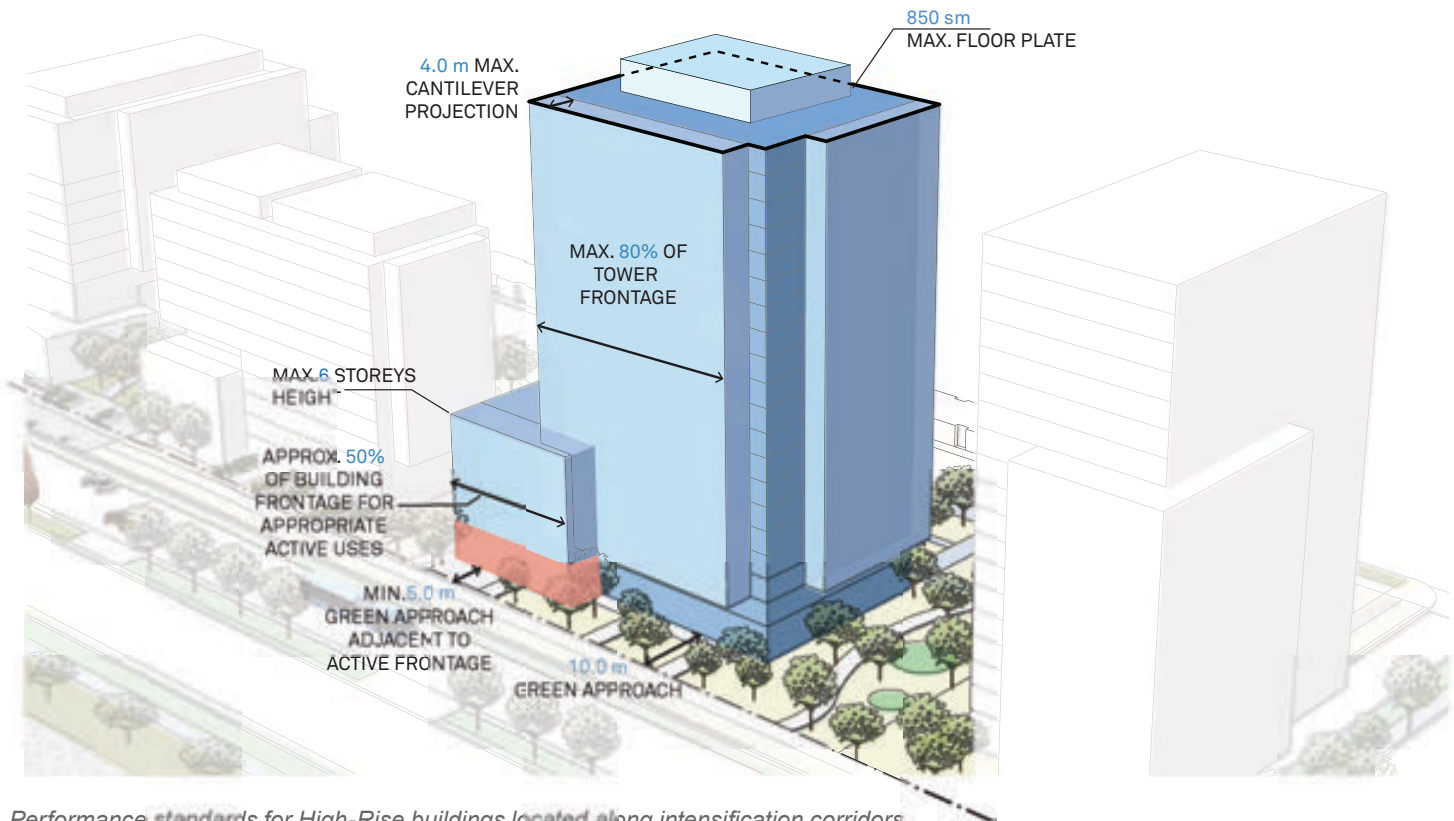

Performance standards for High-Rise buildings located along intensification corridors.

g. On Intensification Corridors:

- » After 40 metres, break up the perceived mass of the building with evenly spaced vertical recesses or other articulation and/or changes in material.
- » High-Rise buildings should be set back 10 metres from the property line to create the front yard landscaped setback that contributes to the Green Approach.
- » Where there are retail/office uses at grade, the building may project into the front yard landscaped setback (Green Approach) a maximum of 5 metres for approximately half of the building frontage. This projected area may include the building floorplates above, up to a maximum of six storeys.
- » Where there are shared residential spaces like lobbies and common amenity spaces at-grade, the building may project into the landscaped setback a maximum of 5 metres for approximately half of the building frontage. This projected area may include the building floorplates above, up to a maximum of six storeys.
- » Townhouse units associated with High-Rise buildings may not project into the front yard landscaped setback, but porches associated with townhouses may project a maximum of 2.5 metres.
- » Upper storey cantilevers may be incorporated above a height of 7.5 metres, projecting from the main building face a maximum of 4 metres and occupying a maximum of 80% of the building frontage.

Performance Standard No. 5.3.2 (continued) High-Rise Building Envelope

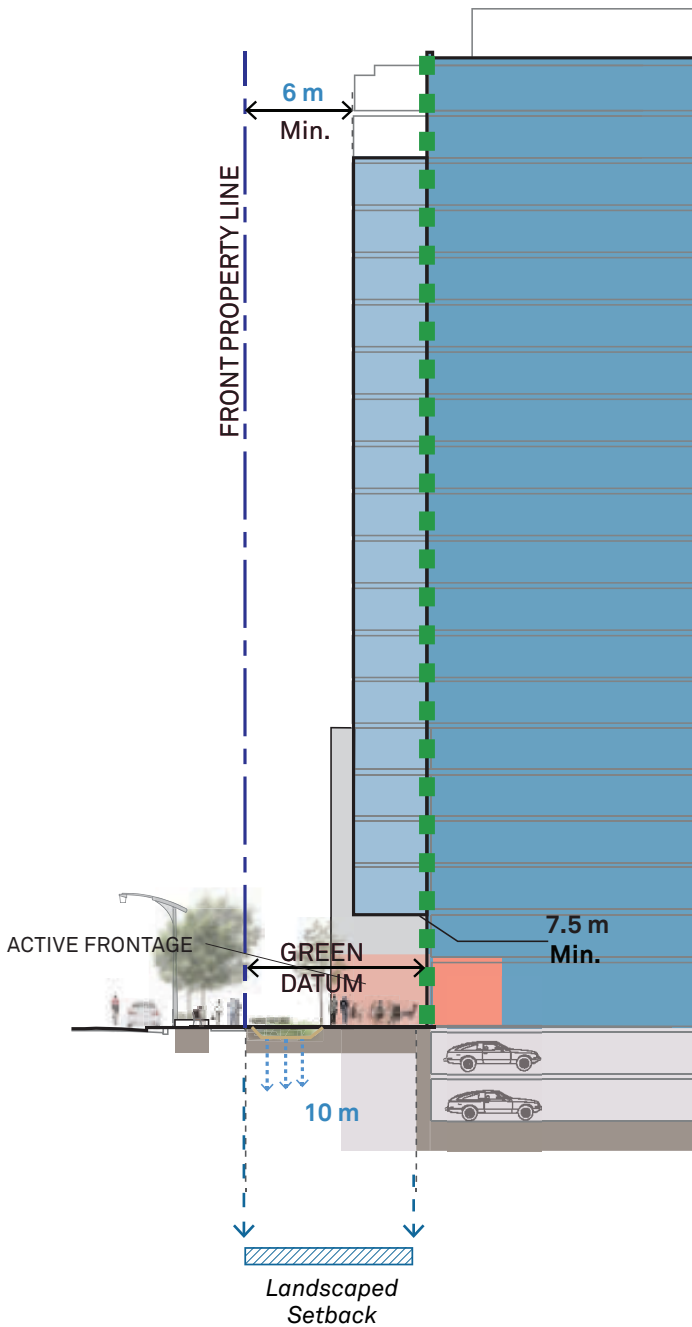

On Intensification Corridors, High-Rise buildings should establish a 10 metre wide front yard setback in support of Vaughan's Green Approach. Projections and cantilevers are permitted to extend within this front yard setback zone.

EXISTING PODIUM/STREETWALL

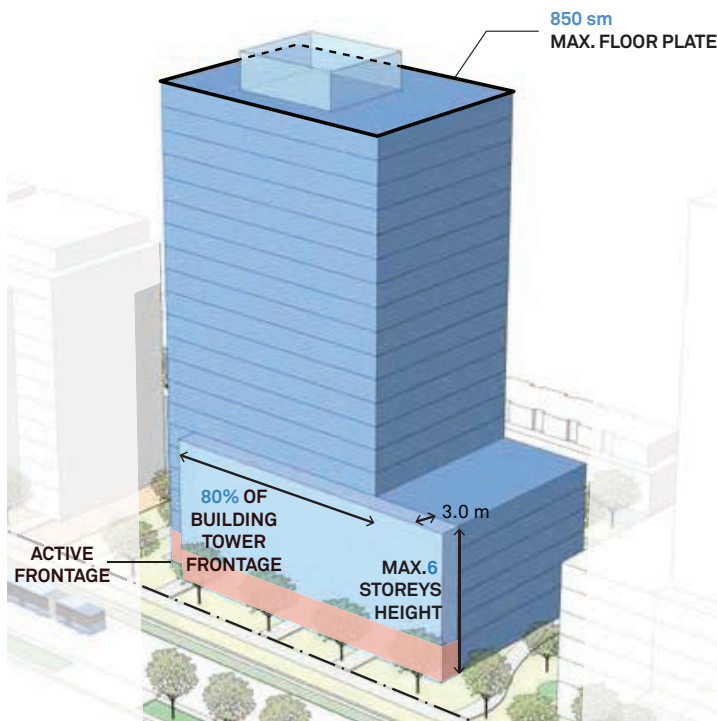

NO EXISTING PODIUM/STREETWALL

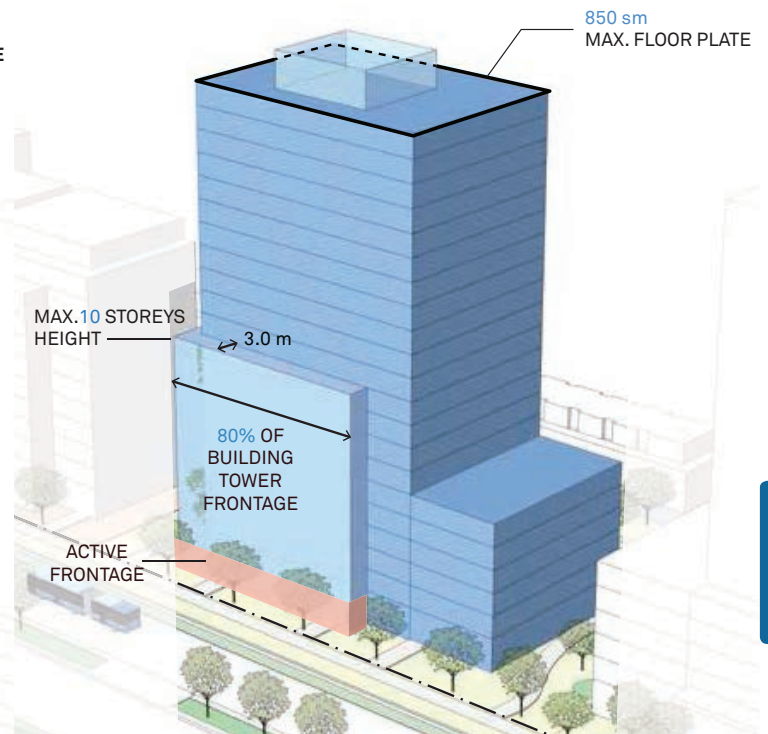

Performance Standards for Alternative High-Rise Envelope (not on Intensification Corridors).

h. In areas of the City that are not Intensification Corridors:

Existing Podium/Streetwall

- » Where a podium form is established, the podium should be three to six storeys in height and the upper storeys should set back a minimum of three metres from the podium.
- » Where a continuous streetwall exists, new buildings should align with existing setbacks and upper storey stepbacks to create consistency in the streetscape.

No Existing Podium/Streetwall

- » Where a podium form is not established in the context, the tower should step back 3 metres within the lower twelve storeys.

- » The Alternative Envelope may have a front yard setback of 3.5 metres minimum from the property line (excluding active uses at-grade). The building envelope should respect the minimum front yard setback as per the zoning by law requirements.

Performance Standard No. 5.3.2 (continued) High-Rise Building Envelope

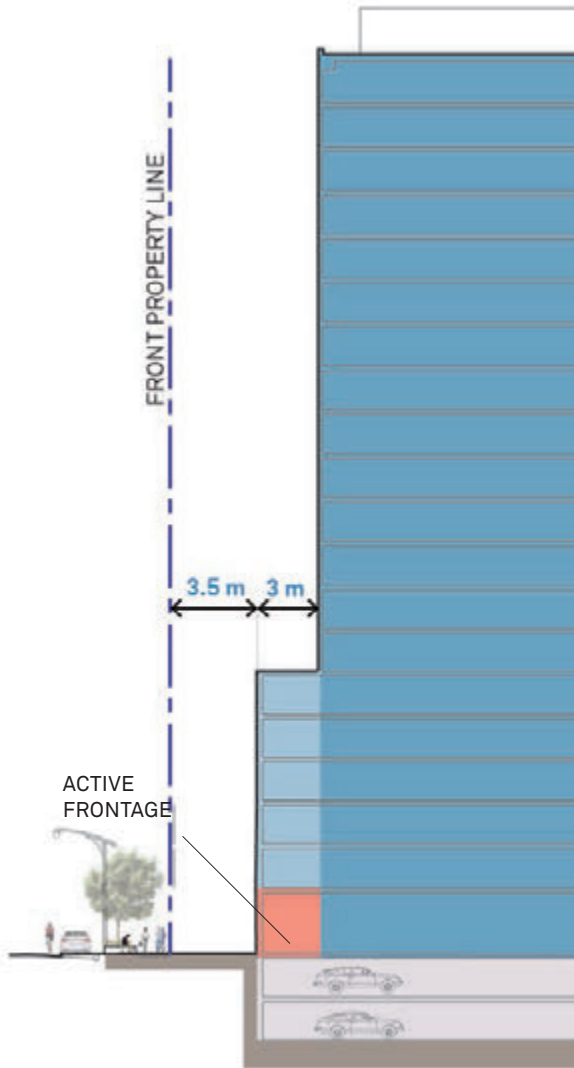

Envelope Performance Standards for Podium at 6-storeys.

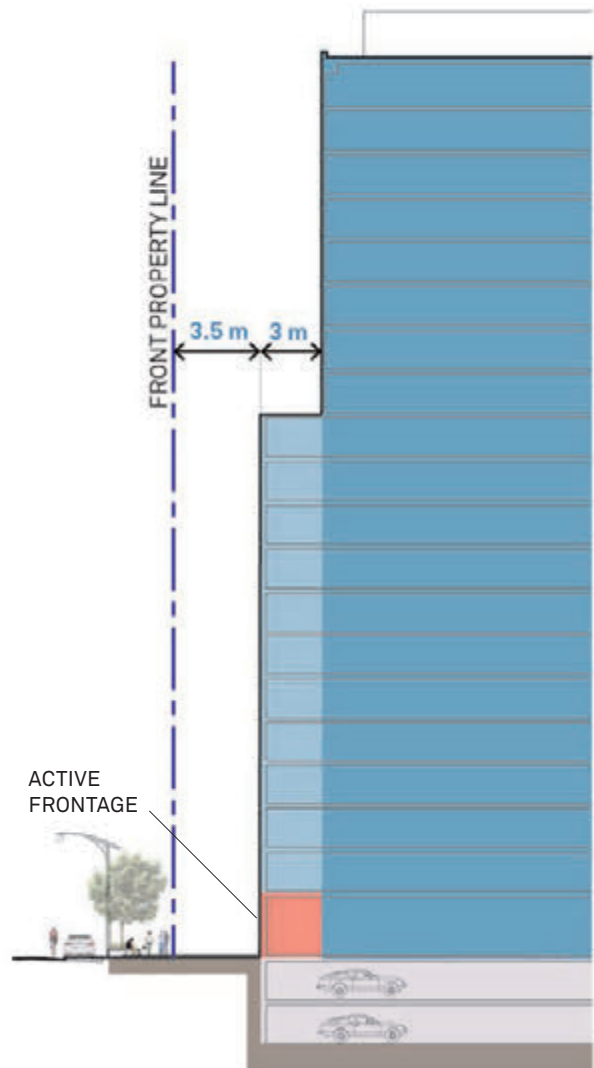

Alternative Envelope Performance Standards for Podiums at maximum twelve storeys for a maximum of 80% of the building tower facade.

Performance Standard No. 5.3.3 Mid-Rise Building Envelope

Mid-Rise buildings are a highly desirable building form for the growing City. Mid-Rise promotes intensification at a human scale and extends the Vaughan Green Approach by enabling living in proximity to the natural environment - particularly where Mid-Rise inhabitants live within, or just above, the height of the City's mature tree canopy.

Mid-Rise Buildings should emphasize compatibility with adjacent development and effective transitions from stable neighbourhoods. Additionally, Mid-Rise building should be an important transitional built form between areas of low to high density development.

Key guidelines:

- Performance Standard 6.1.1 The Green Approach
- Building Design Performance Standards 5.3.6-5.3.14
- Building Use Performance Standards (Sections 7.2-5 and 7.6)



Mid-Rise buildings can promote design excellence through permitting creative and contemporary building practices. (Image Credit: Brook McIlroy)

Key policy references:

- City of Vaughan Official Plan, Chapters 5 and 9

Performance Standard No. 5.3.3 (continued) Mid-Rise Building Envelope



Mid-Rise buildings provide an effective transition between neighbourhoods and areas of low-density development to areas of higher density development. (32 Camden Street, Toronto. Image Credit: Brook McIlroy)

General Mid-Rise Building Directions:

- a. Mid-Rise buildings are between six and twelve storeys in height.
- b. Mid-Rise buildings are inherently human-scaled and should enable maximum design flexibility with minimum constraint to massing except to mitigate the height and bulk of the building above the sixth storey.
- c. Similar to High-Rise buildings, Mid-Rise building design should create variety and design flexibility at the grade, podium and upper building levels to promote creative and contemporary design practices through building projections and terraces.
- d. Mid-Rise buildings shall be designed to provide a positive micro-climate, such as reducing wind downdrafts.
- e. Mid-Rise buildings should be no longer than 80 metres in length. Longer buildings must be broken up by building components that are sufficiently set back or of different heights to visually appear as two separate buildings from grade.

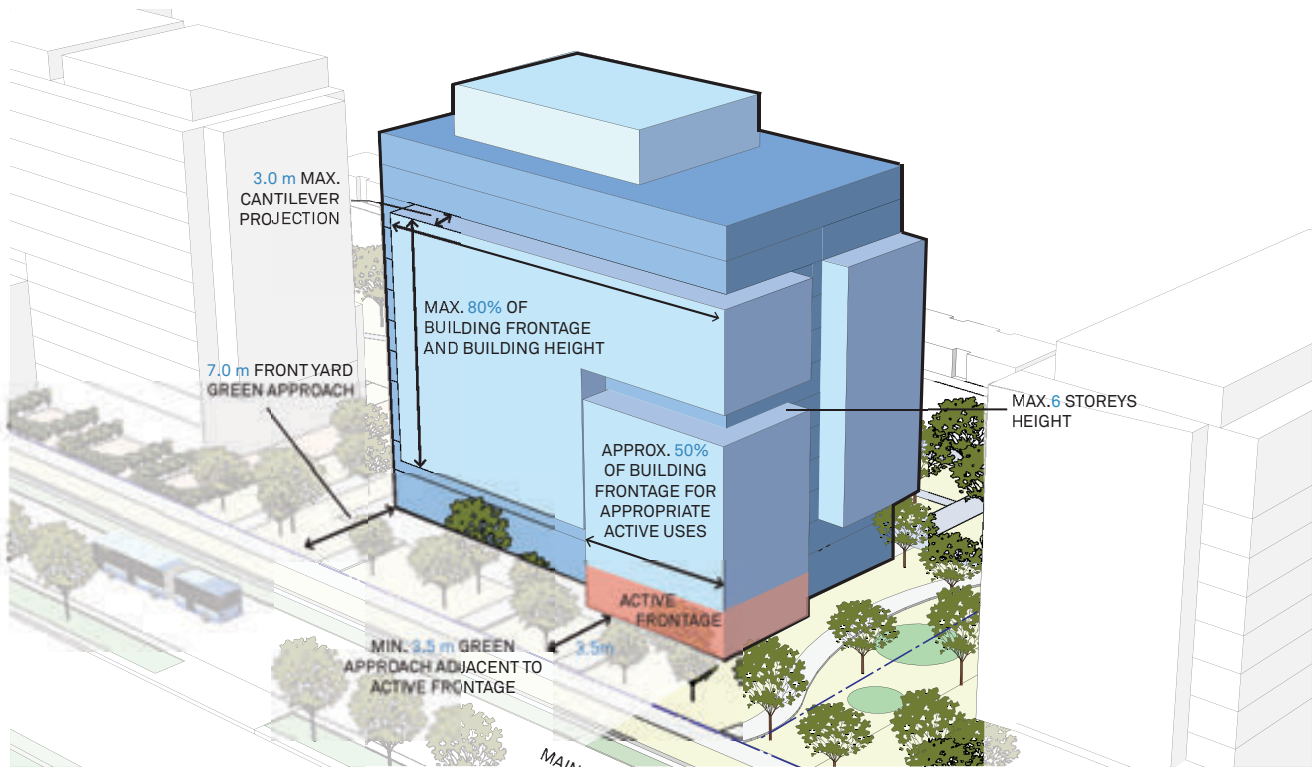

Performance Standards for a Mid-Rise Building on an Intensification Corridor.

f. On Intensification Corridors:

- » Mid-Rise Buildings should establish a 7 metre wide front yard landscaped setback (in support of the Green Approach) from the front property line.
- » Where there are retail/office uses at grade, the building may project into the landscaped setback a maximum of 3.5 metres for approximately half of the building frontage. This projected area may include the building floorplates above, up to a maximum of six storeys.
- » Where there are shared residential spaces like lobbies and common amenity spaces at grade, the building may project into the front yard landscaped setback a maximum of 3.5 metres for approximately half of the building frontage. This projected area may include the building floorplates above, up to a maximum of six storeys.
- » Townhouse units associated with Mid-Rise buildings may not project into the landscaped setback, but porches associated with townhouses may project a maximum of 2.5 metres.
- » Upper storey cantilevers may be incorporated above a height of 7.5 metres, projecting from the main building face a maximum of 3.5 metres and occupying a maximum of 80% of the building frontage and 80% of building height.

Performance Standard No. 5.3.3 (continued) Mid-Rise Building Envelope

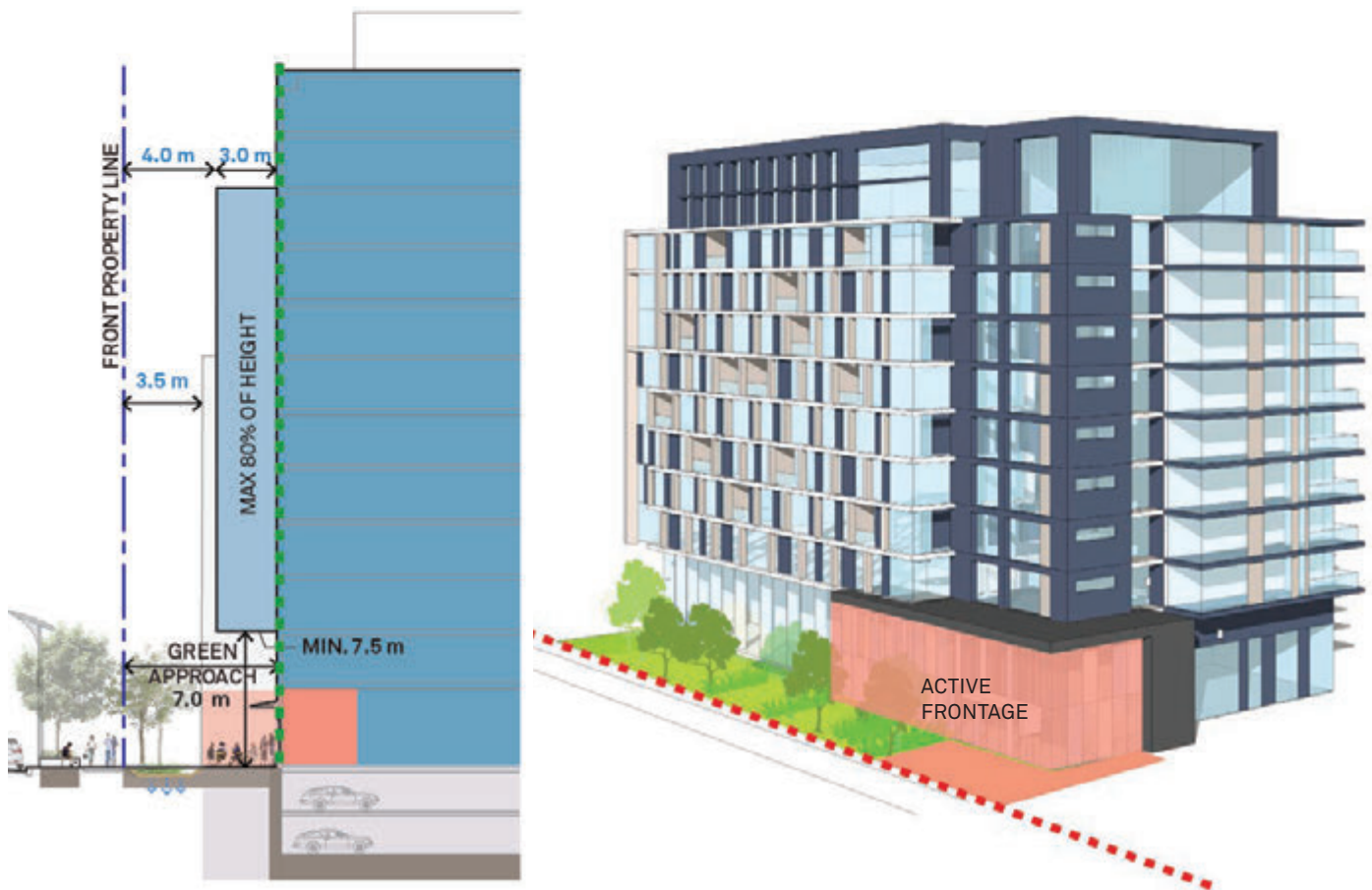

On Intensification Corridors, Mid-Rise buildings should establish a 7 metre wide front yard Green Approach. Projections and cantilevers are permitted to extend this area above 7.5 metres.

EXISTING PODIUM/STREETWALL

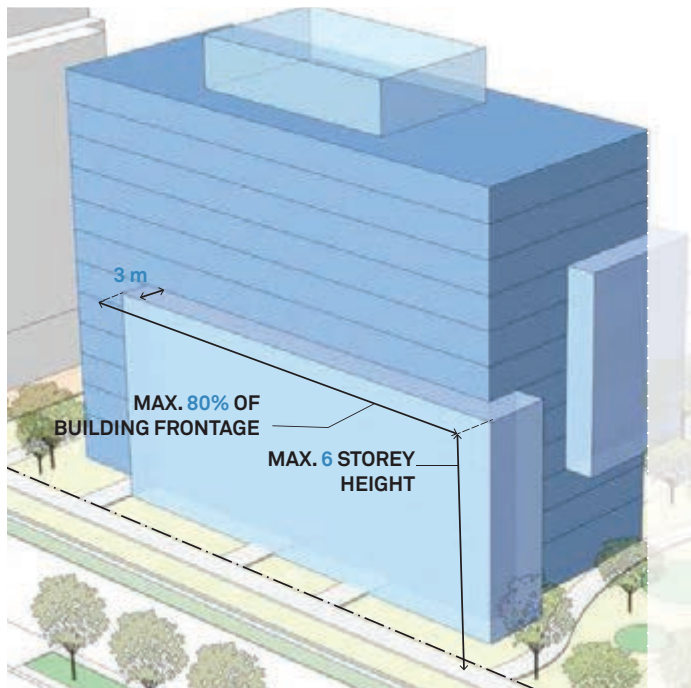

NO EXISTING PODIUM/STREETWALL

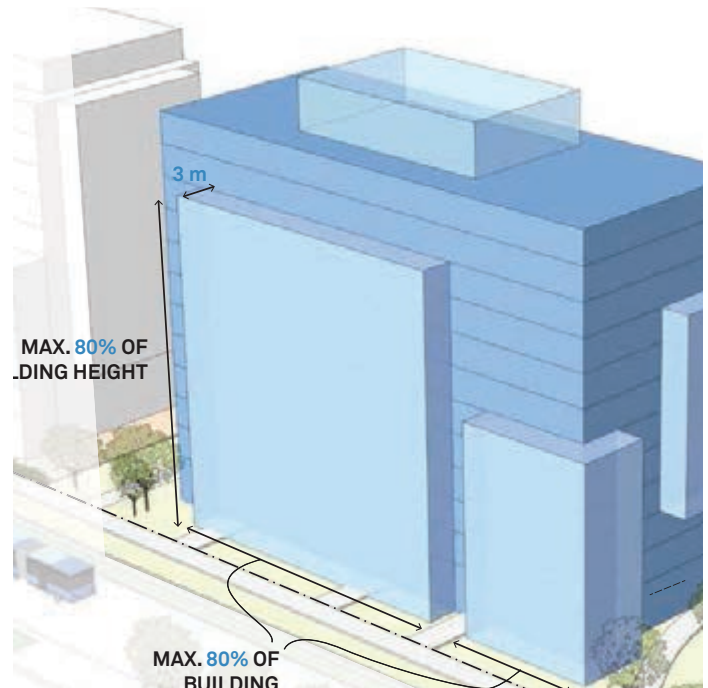

Performance standards for Mid-Rise buildings that are not located on intensification corridors.

g. In areas of the City that are not Intensification Corridors:

- » The building envelope should respect the minimum front yard setback as per the zoning by law requirements.

Existing Podium/Streetwall

- » Where a podium form is established, the podium should be a maximum of six storeys in height and the upper storeys should step back a minimum of 3 metres.

- » Where a continuous streetwall exists, new buildings should align with existing setbacks and upper storey step-backs to create consistency in the streetscape.

No Existing Podium/Streetwall

- » Where a podium form is not established, upper storey cantilevers may occupy 80% of the building height and frontage and may project up to 3.5 metres from the front property line.

Performance Standard No. 5.3.3 (continued) Mid-Rise Building Envelope

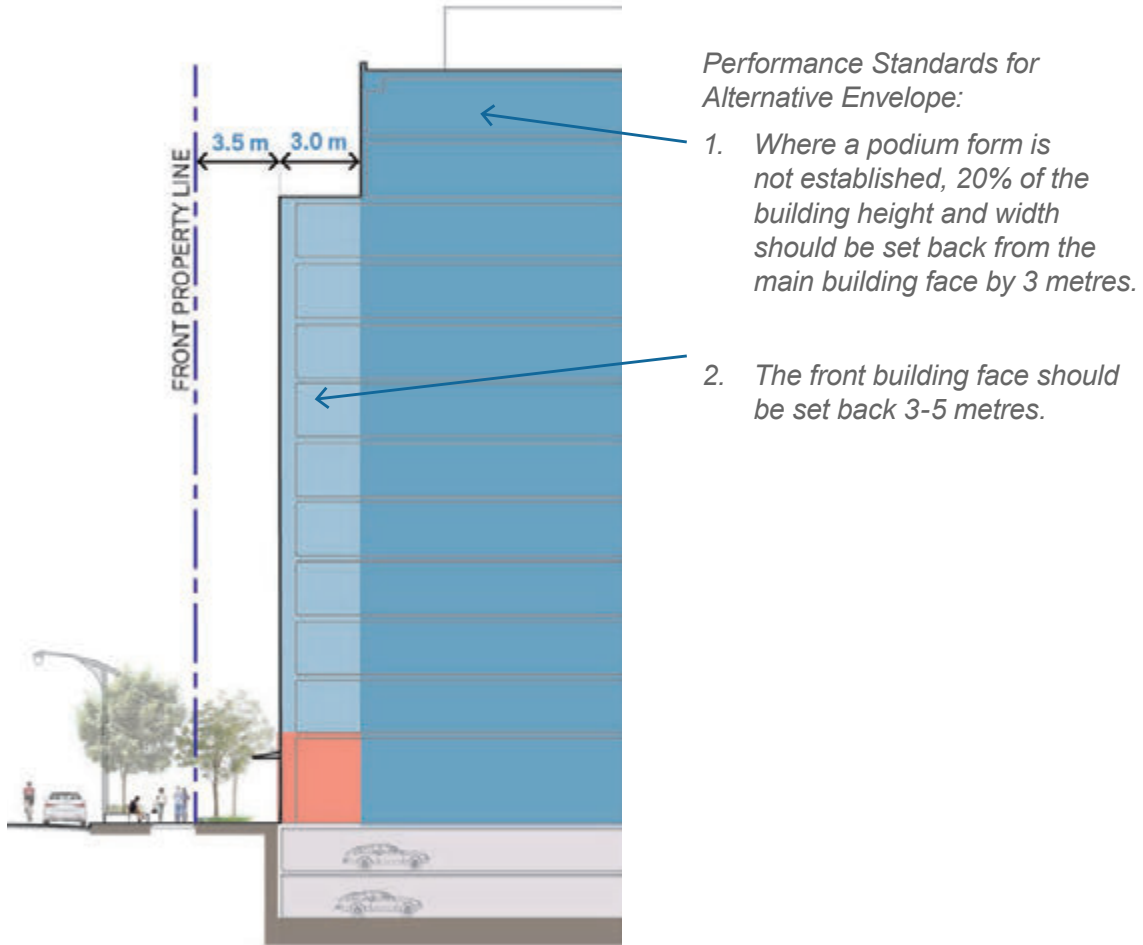

Performance standards for Mid-Rise buildings not located on intensification corridors.

Performance Standard No. 5.3.4

Low-Rise Building Envelope

Low-Rise buildings fit well within existing neighbourhoods and may contain a mix of residential, commercial, institutional and employment uses. These buildings should frame streets, reduce the visual impact of parking and contribute to the City's network of neighbourhood main streets and open spaces. The following guidelines refer to infill buildings outside of Low-Rise Residential neighbourhoods.

- a. Low-Rise buildings are up to five storeys in height.
- b. Low-Rise buildings should be designed to promote pedestrian comfort at grade.
- c. Low-rise buildings should be located to frame streets, open spaces and landscaped areas.
- d. Infill buildings should be compatible with the existing building context with respect to grade level design, cornice lines, window proportion and roof design.
- e. Low-Rise buildings should be no longer than 80 metres in length (with the exception of townhouses - see Performance Standard 7.3.2). Longer buildings must be broken up by building components that are sufficiently set back or of different heights to visually appear as two separate buildings from the grade level.
- f. On Intensification Corridors, Low-Rise buildings should follow Performance Standards for Mid-Rise buildings on Intensification Corridors to establish a 7 metre deep front yard setback (see Performance Standard 5.3.3).

LOW RISE BUILDINGS ARE UP TO FIVE STOREYS IN HEIGHT



Low-Rise buildings should be designed to frame streets, open spaces and landscaped areas. (Image Credit: Armstrong Place Senior Housing, San Francisco, David Baker + Partners. Photo by Brian Rose)

Key guidelines:

- Performance Standard 4.3.7 Development Adjacent to Cultural Heritage
- Performance Standard 5.3.3: Mid Rise Building Envelope
- Building Use Performance Standards (Sections 7.2-6)

Key policy references:

- City of Vaughan Official Plan, Chapter 9
- City of Vaughan Urban Design Guidelines for Infill Development in Established Low-Rise Residential Neighbourhoods

Performance Standard No. 5.3.5 Townhouse Design

Townhouses are a compact single family house form that fit well within or adjacent to stable neighbourhoods and mixed-use community contexts. Townhouses should be designed to ensure permeability within groupings and to provide access to sunlight, views and privacy for residents. The same guidelines for minimum width and encroachments should apply for townhouse units that wrap Mid- or High-Rise buildings at grade. The following guidelines refer to infill buildings outside of Established Low-Rise Residential Neighbourhoods.

- a. Townhouse blocks should not exceed 80 metres.
- b. Pathways and connections should be provided between rows to facilitate pedestrian and cyclist site circulation and access to adjacent networks, transit stops, etc.
- c. Townhouse units should be a minimum of 5.5 metres in width. To promote a variety of widths, no more than 50% of townhouses within a development should be built to the minimum width.
- d. Rear laneways, connected rear garages, and underground parking are preferred over integrated front garages to promote habitable front facing rooms and well-landscaped front yards.
- e. Where there is an integrated front garage, it may occupy a maximum of 50% of the unit frontage. Driveways should be paired to consolidate landscaped front yards between units.
- f. Entrances to individual units should be no more than 1.5 metres above existing grade.
- g. On Intensification Corridors, townhouses should provide a 7 metre minimum front setback with a landscaped 3.5 metre “no encroachment” zone, in which no steps or porches should extend.
- h. In areas of the City that are not Intensification Corridors, townhouses should incorporate a minimum 4.5 metre front setback with a 2.0 metre “no encroachment” zone.
- i. Front porches may project a maximum of 2.5 metres from the main building face.
- j. The rear facade of townhouses should be set back a minimum of 12 metres from the rear property line if the design includes a rear yard and rear garage.
- k. Decks and terraces are permitted to encroach 2.5 metres into the rear yard and should be set back within the side walls of the townhouse.
- l. The rear facade of townhouses should be set back from a rear garage or surface parking area a minimum of 5 metres.
- m. Rear garages should be set back from the rear lane a minimum of 1.2 metres.
- n. Decks are permitted above a rear garage for tight infill developments.

Performance Standard No. 5.3.5 (continued) Townhouse Design



Entrances to individual units should be no more than 1.5 metres above existing grade and incorporate a 4.5 metre front yard setback. (Image Credit: Brook McIlroy).

Key guidelines:

- Performance Standard: The Green Approach
- Performance Standard 7.3.2 Townhouses

Key policy references:

- City of Vaughan Official Plan, Chapter 9
- City of Vaughan Urban Design Guidelines for Infill Development in Established Low-Rise Residential Neighbourhoods

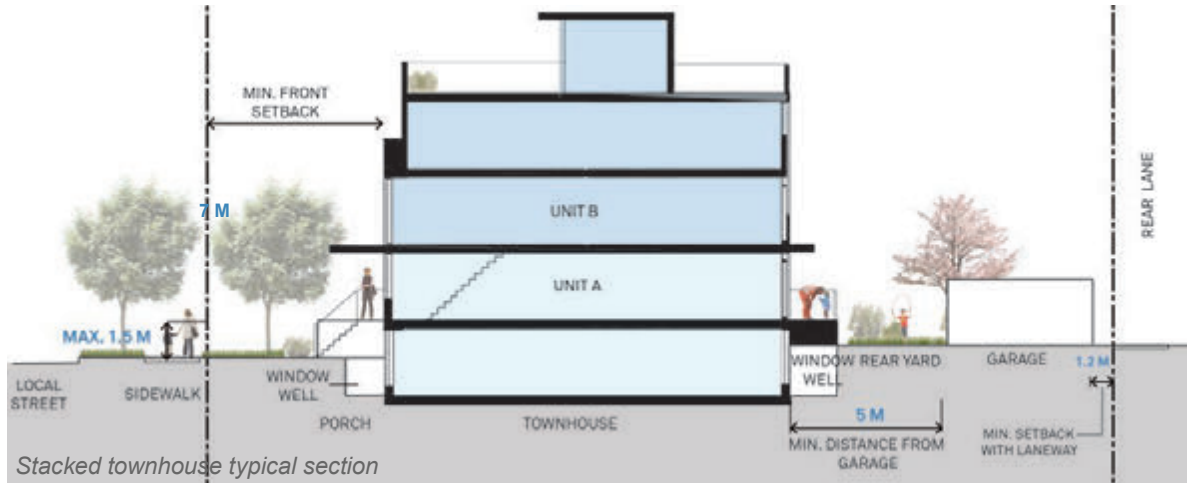

Stacked townhouse typical section

o. Stacked Townhouses

- » Stacked townhouses provide direct access to each residential unit within a compact format, with one unit stacked upon another. Units may be accessed by a shared landing with internal staircases or an external staircase providing individual unit access.

- » Stacked townhouses may be up to four storeys in height.
- » Stacked townhouses should be designed to resemble a traditional townhouse, with vertical articulation identifying each module of units.
- » Stacked townhouses may have a maximum building length of 50 metres.

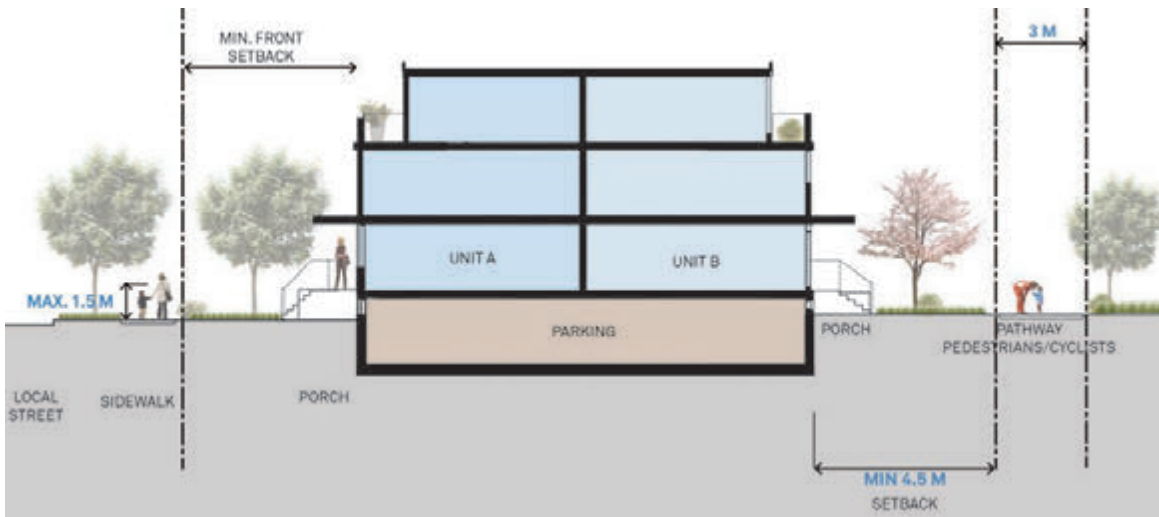

p. Townhouses with Two Active Frontages (Back to Back Townhouses)

- » Back-to-back townhouses provide a primary building frontage on two sides, with units sharing a rear wall, to avoid back-lotting onto pathways, lanes and streets. They may be up to three storeys in height.

Performance Standard No. 5.3.5 (continued) Townhouse Design

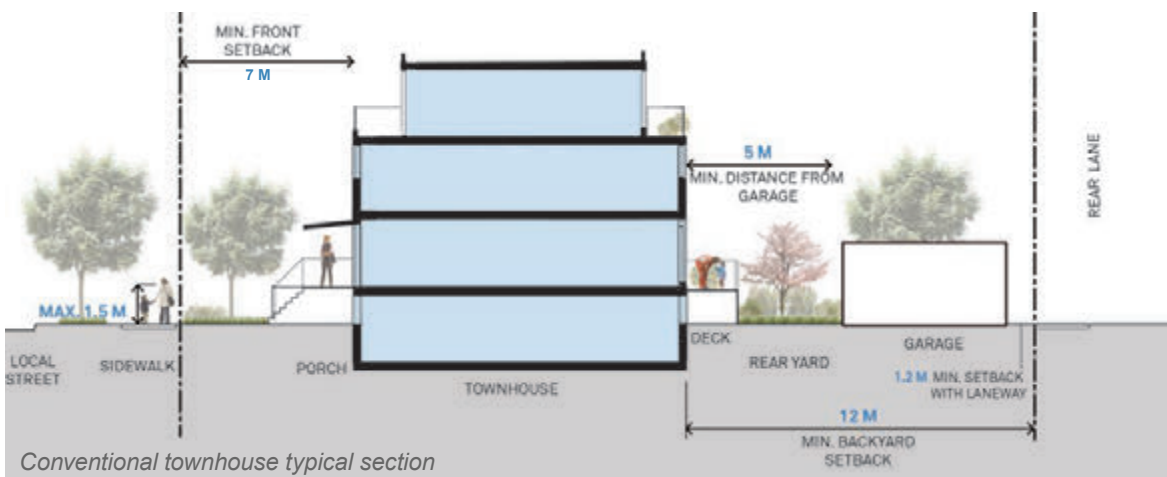
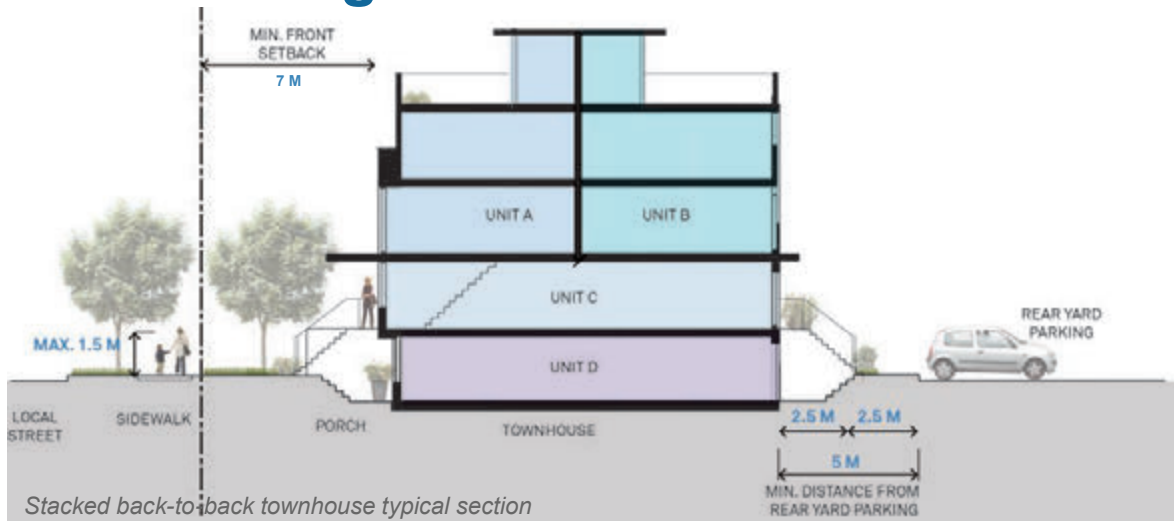

ENTRANCE STAIRWELL SHOULD NOT BE A DOMINANT ELEMENT IN THE FACADE



The entrance stairwell in below grade units should not be a dominant element in the building facade. (Image Credit: Pinterest)

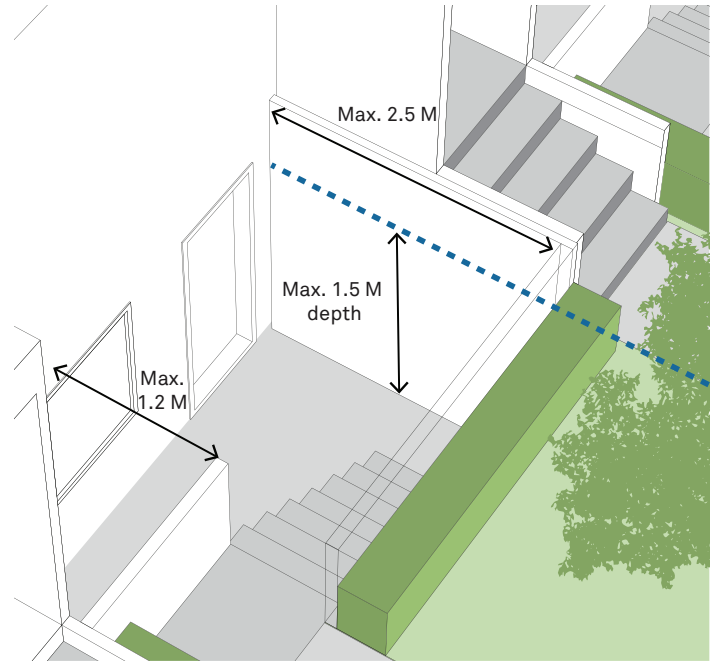

Below grade threshold performance standards.

Below Grade Entrances

- » Where below-grade thresholds for basement townhouse units cannot be avoided, the entrance stairwell should not be a dominant element in the facade of the building or against the street.
- » These below-grade landing areas may encroach a maximum of 2.5 metres into the front yard setback. The maximum threshold depth from door to stair should be 1.2 metres and the maximum distance from entrance to grade level should be 1.5 metres.

Performance Standard No. 5.3.6

Built Form Transitions

Effective built form transitions should be applied within single buildings, between buildings on a site, on a block, and across areas of the City. Built form transitions are applied to reduce the shadow, view and overlook impacts for adjacent residents, open spaces and future building occupants. Transitions to adjacent properties should also consider existing building open space separation distances. Shadow analysis should be used to provide guidance to balance significant view and privacy conditions between properties.

Key guidelines:

- Performance Standard 5.2.1 Building Location and Orientation
- Performance Standard 5.3.2 High-Rise Buildings
- Performance Standards 5.3.3 Mid-Rise Buildings

- a. Where a continuous streetwall already exists, maintain a consistent base building height with neighbours, varying by a maximum of two storeys.
- b. On sites with multiple buildings, organize buildings so that taller building components are located away from areas of Low-Rise development.
- c. Where a rear yard transition to a Low-Rise property exists, High-Rise, Mid-Rise and Low-Rise buildings should provide the following transitions:
 - » High-Rise buildings should be set back a minimum of 7.5 metres from the rear property line and the first twelve storeys of the building should be contained within a 45 degree angular plane from the rear property line. Above the twelfth storey, an angular plane is not required.
 - » Mid-Rise and Low-Rise buildings should be set back a minimum of 7.5 metres from the rear property line and should be contained within a 45 degree angular plane from the rear property line.

Key policy references:

- City of Vaughan Official Plan, Chapters 2 and 9

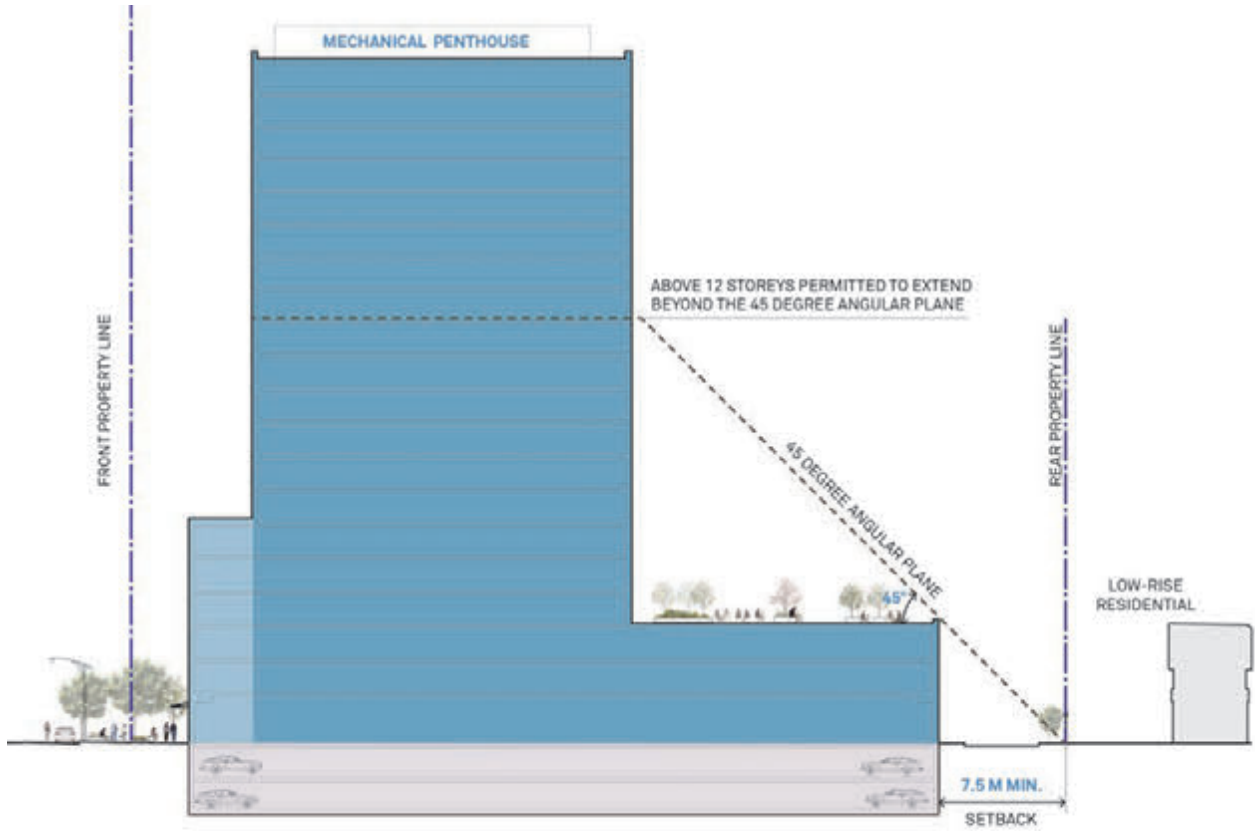

High-Rise building rear yard transition.

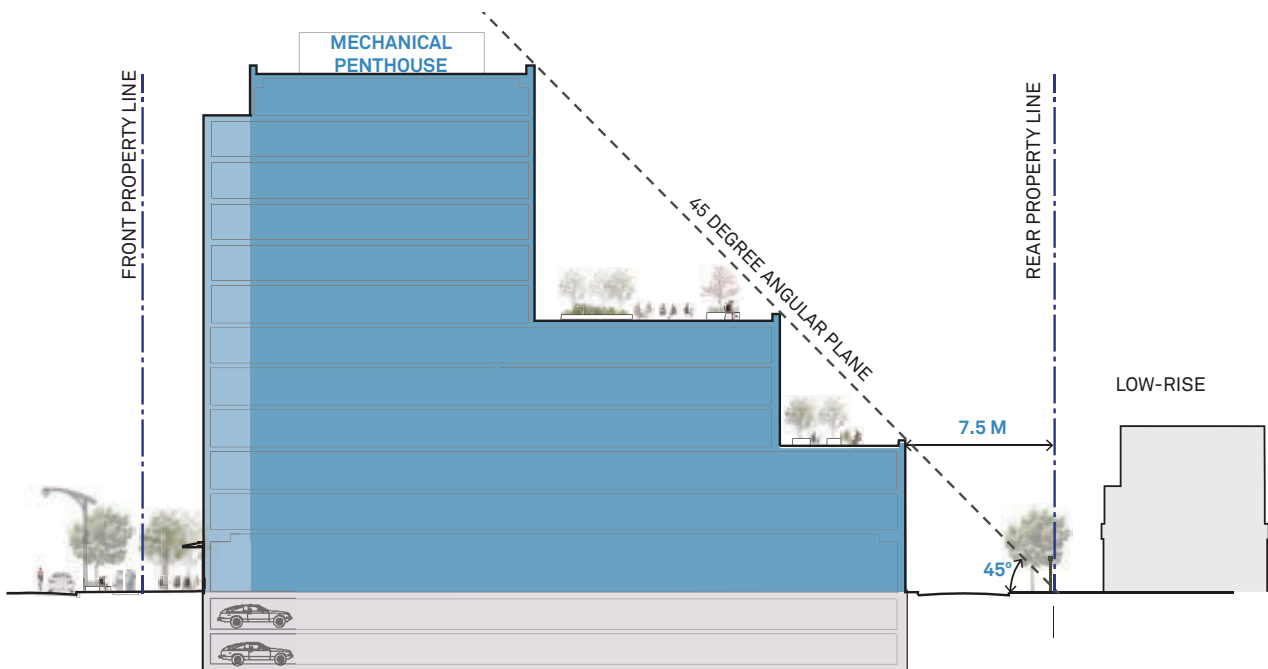

Mid-Rise building rear yard transition.

Performance Standard No. 5.3.6 (continued) Built Form Transitions

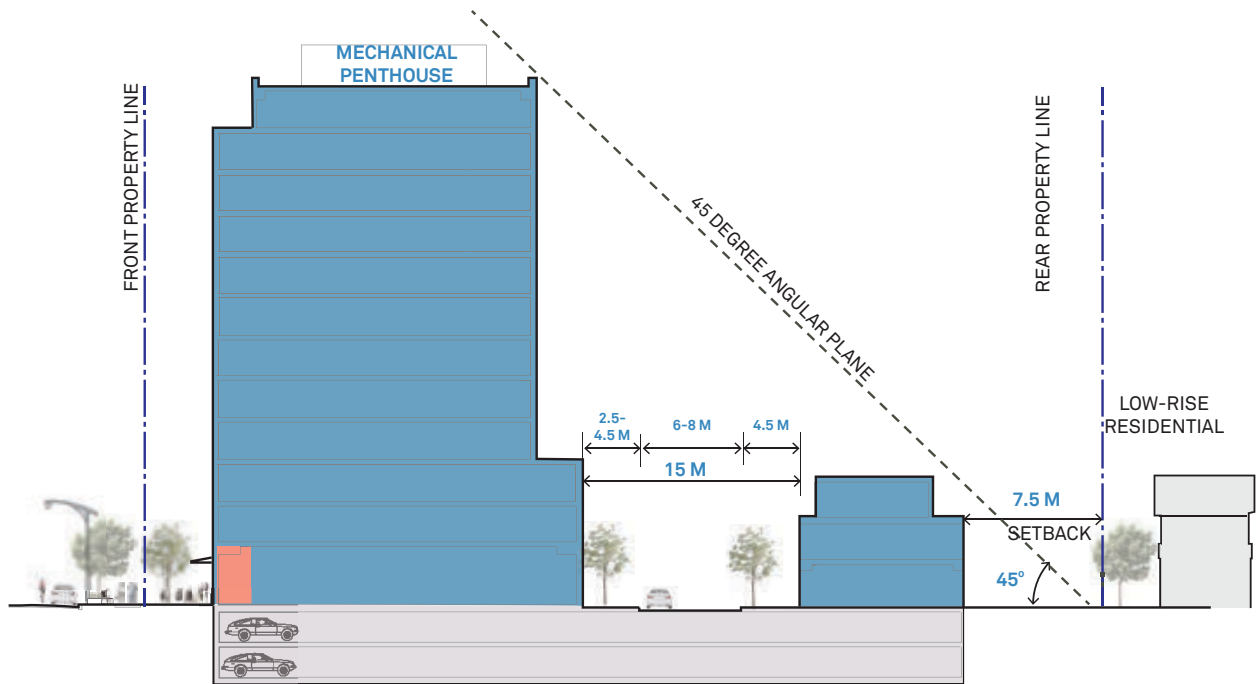

Mid-Rise building: Preferred rear yard transition to Low-Rise residential neighbourhood.

- d. Where a rear yard transition to a Low-Rise residential neighbourhood exists, new High-Rise or Mid-Rise building sites are encouraged to create a transition that incorporates townhouse units between the new building and the existing neighbourhood.

Performance Standard No. 5.3.7

Separation Distances

Separation distances between buildings should allow for a pedestrian or vehicular connection between buildings and to create sufficient separation between habitable windows.

a. For High-Rise buildings:

- » Up to six storeys, a minimum side yard separation distance of 15 metres should be provided between habitable windows. This area should be clear of building projections, cantilevers and encroachments.
- » Above six storeys, a minimum 30 metre separation distance between towers (including towers that share a podium) should be provided between habitable windows. This area may incorporate projections or cantilevers that extend a maximum of 2.5 metres from the main building face.

b. For Mid-Rise buildings:

- » Up to six storeys, a minimum side yard separation distance of 15 metres should be provided between habitable windows. This area should be clear of building projections, cantilevers and encroachments.
- » Above six storeys, a minimum 20 metre separation distance should be provided. Balconies on the main building face are permitted to project a maximum of 2.5 metres.

Key guideline:

- Performance Standard 5.2.11 Mid-Block Connections / Mews

Key policy reference:

- City of Vaughan Official Plan, Chapter 9

Performance Standard No. 5.3.7 (continued)

Separation Distances

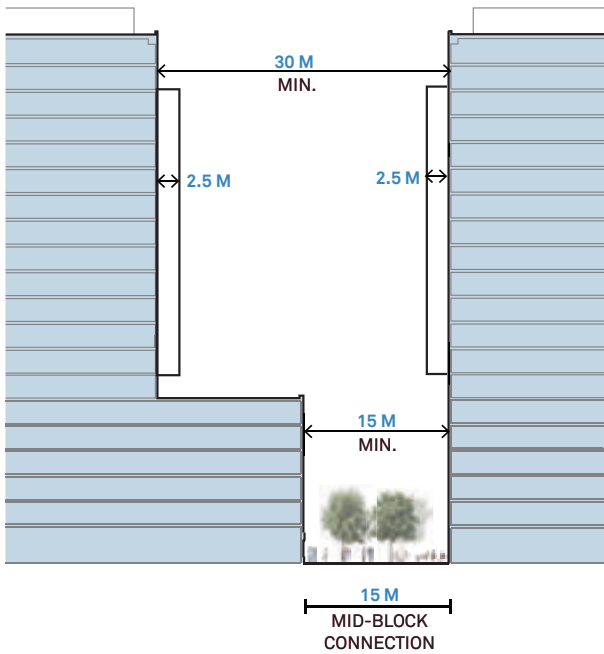

Typical separation distances between High-Rise buildings.

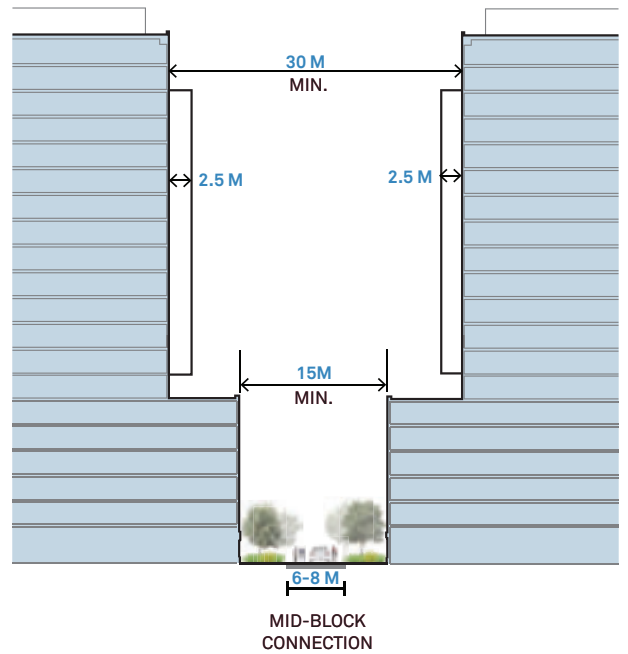

Typical separation distances between High-Rise buildings and podiums.

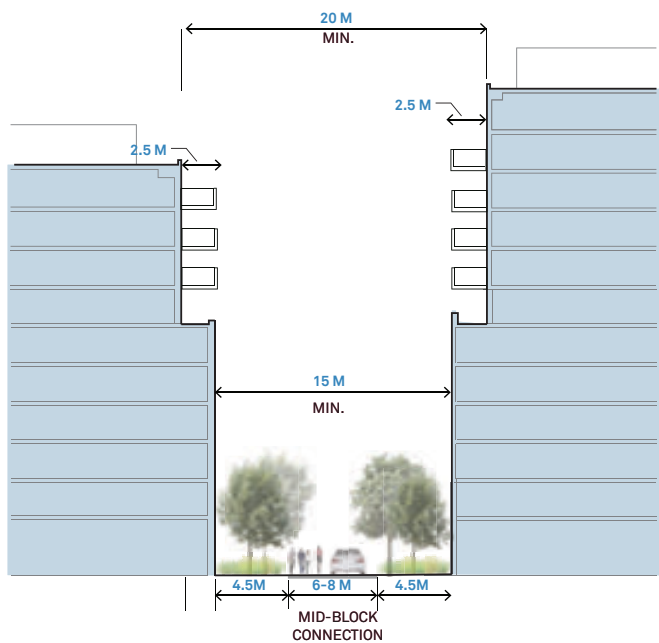

Separation distances between Mid-Rise buildings.

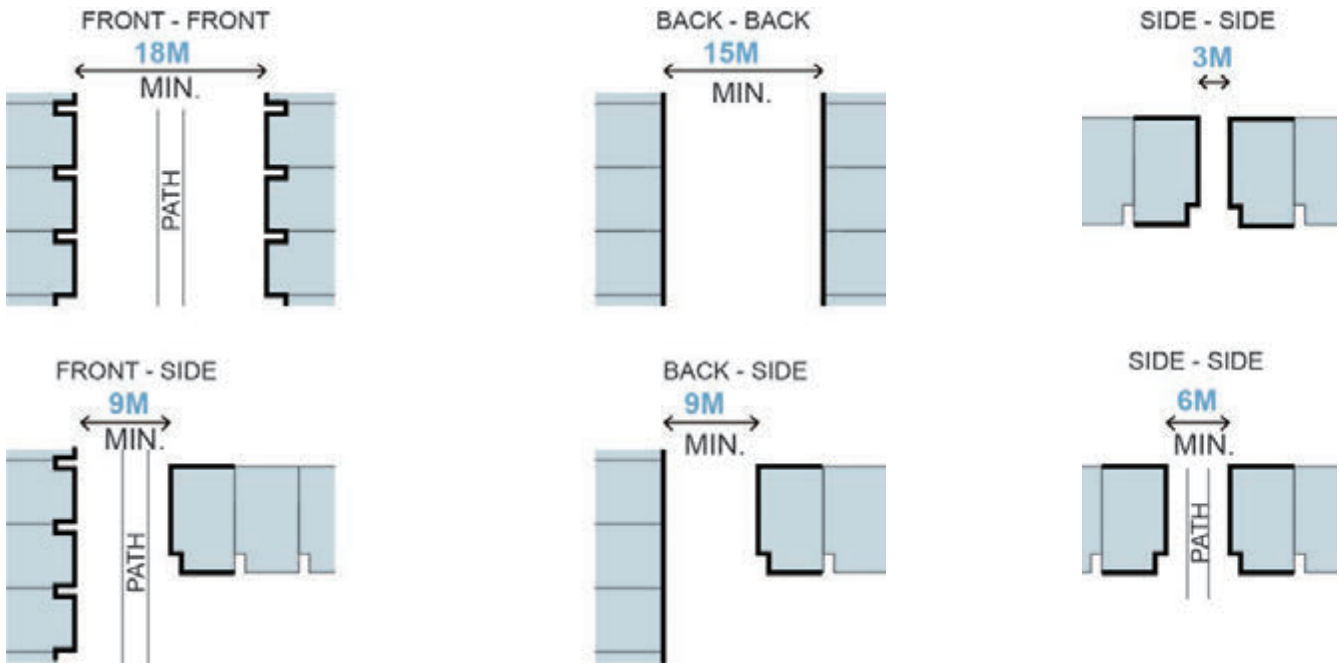

Separation distances between Low-Rise buildings.

c. For Low-Rise buildings, Including Townhouses:

- » A minimum facing distance of 18 metres should be provided between primary building faces to accommodate a pathway and front yard landscape. The pathway should be a minimum of 3 metres wide.
- » A minimum back-to-back separation distance should be provided between townhouse groupings to accommodate two rear yards that are a minimum depth of 7.5 metres.
- » A minimum side-side distance of 3 metres should be provided where no pathway or pathway is provided between Low-Rise or townhouse groupings.
- » A minimum side-side distance of 6 metres should be provided where a pathway or pathway is provided between Low-Rise or townhouse groupings.
- » A minimum 9 metres should be provided where there is a front-to-side condition to accommodate a 4.5 metre front yard, a 3 metre pathway and a 1.5 metre side setback.
- » A minimum 9 metres should be provided where there is a back-to-side condition to accommodate a 7.5 metre rear yard and a 1.5 metre side setback.

Performance Standard No. 5.3.8

Thresholds and Entrances

A strong relationship between the building and the street is established through the design of thresholds and entrances. Their design should respond to the function of the street to support an active public realm.

- a. Entrances should consider weather protection, including overhangs, cantilevers and awnings.
- b. Primary building entrances should address public streets. Buildings on corners should provide a main entrance on the primary and the flanking frontage.
- c. Thresholds and entrances should be designed for the ultimate use of the site, regardless of whether a temporary or interim use will occupy the ground levels. Where mixed-use is permitted, ground floors should be designed to accommodate retail, institutional or office uses.
- d. Windows to permit natural light in below-grade units are encouraged.

Key guidelines:

- Performance Standard 5.3.5 Townhouse Design
- Performance Standard 5.3.9 Facade Design and Materials
- Performance Standard 5.3.14 Building Elements
- Performance Standard 6.1.1 The Green Approach

- e. The design of thresholds should transition seamlessly to the Regional boulevard treatments by choosing complimentary materials and ensuring that grading does not create any trip hazards.

Key Dimensions:

- f. Where below-grade thresholds for basement townhouse units cannot be avoided, the entrance stairwell should not encroach more than 2.5 metres on the minimum front yard setback. The maximum threshold depth from door to stair should be 1.2 metres and the maximum distance from entrance to grade level should be 1.5 metres.
- g. The ground floor of all Mid- and High-Rise buildings and for Low-Rise buildings on intensification corridors (except townhouses) should be a minimum of 4.5 metres floor-to-floor

Key policy reference:

- City of Vaughan Official Plan, Chapter 9

MIXED USE BUILDING THRESHOLDS

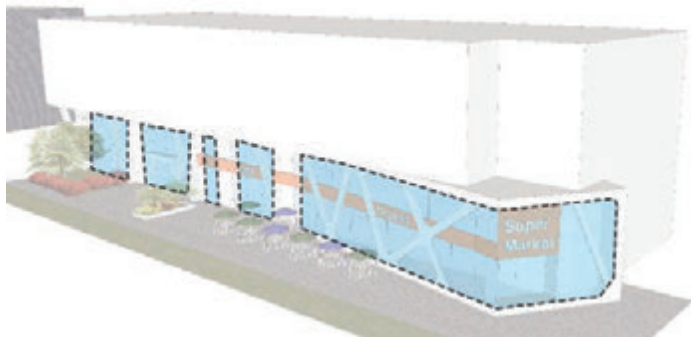
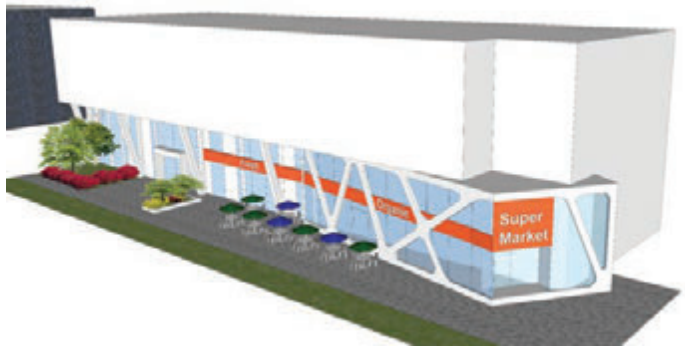

Significant clear glazing at ground level.

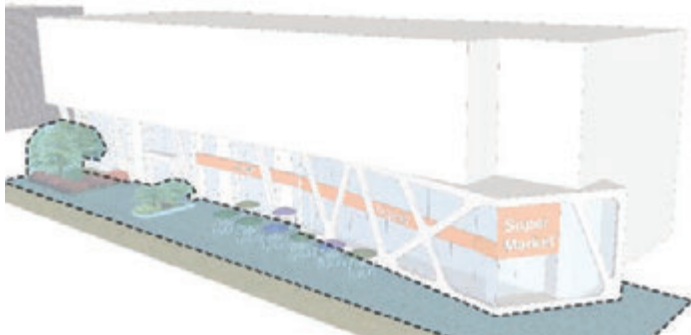

Active public realm with spill-out uses and landscape.

RESIDENTIAL BUILDING THRESHOLDS

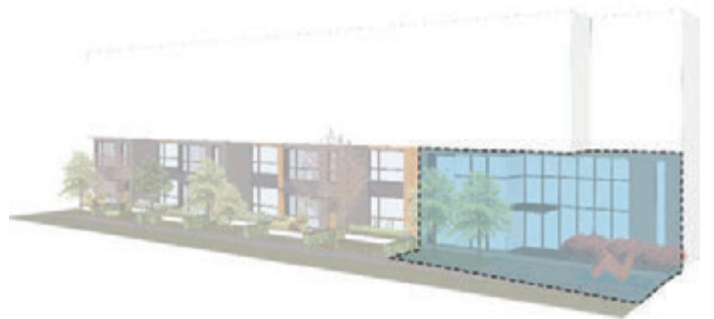

Lobbies should create strong connections to the public realm.

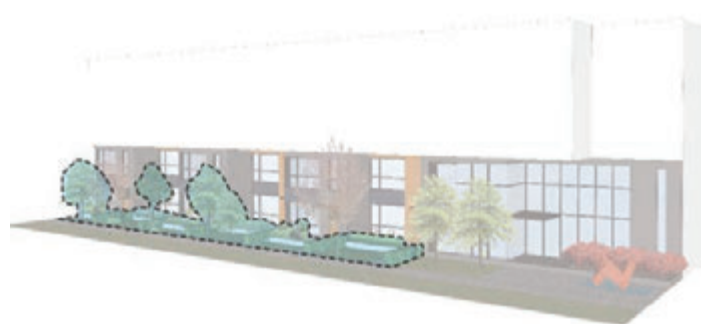

Private residential landscape for transition between private and public realm.

Performance Standard No. 5.3.8 (continued)

Thresholds and Entrances

to accommodate internal servicing and loading on the ground level, increase the prominence of building entrances, and to accommodate future conversion to retail (where appropriate).

h. Shared Residential Entrances in Residential or Mixed-Use Buildings

- » Grade changes should be avoided from the public street to shared entrances or lobbies.
- » The entrance should convey its shared character, through taller floor-to-floor heights, double doors and more significant glazing.
- » Pedestrian amenities like lighting, bicycle parking or benches may be clustered at the entrance.
- » A mix of hard and soft landscape may be incorporated.
- » A minimum of 50% soft landscape should be provided within the front setback area where residential units are at-grade, while a minimum of 15% soft landscape should be provided for shared entrances and commercial frontages.
- » Raised planters are discouraged, but where they are incorporated, they should provide integrated seating.

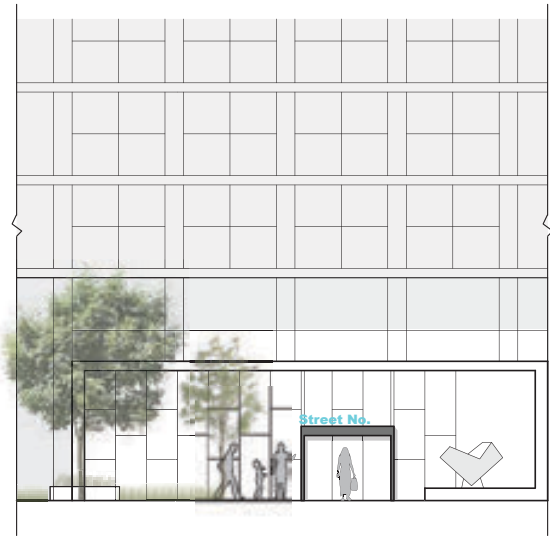

Elevation of residential shared entrance threshold.

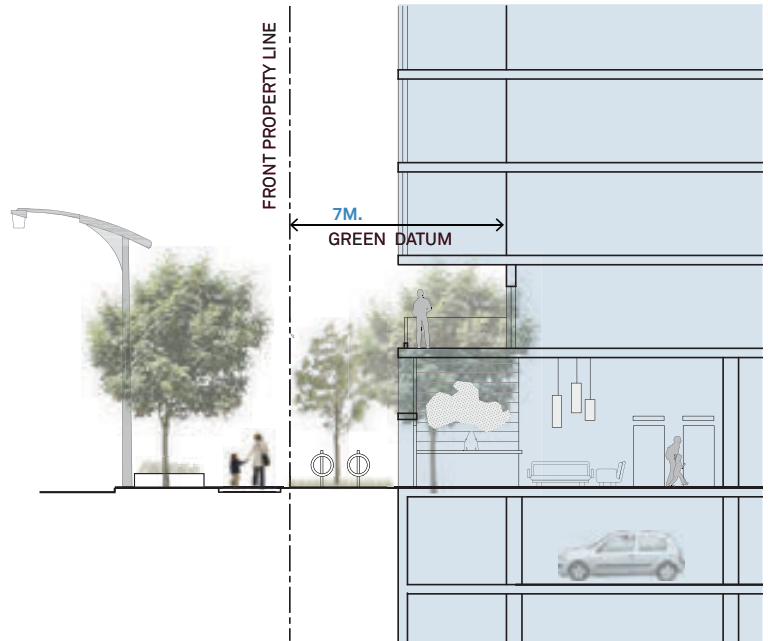

Section through residential shared entrance threshold.

SECTION 5



A mix of pedestrian amenities is clustered at the entrance to convey its shared character. (Image Credit: Pinterest)



Shared entrance with a double height lobby space and a mix of soft and hard landscape. (La Casa Permanent Supportive Housing / Studio Twenty Seven Architecture + Leo A Daly. Image Credit: ArchDaily)

Performance Standard No. 5.3.8 (continued)

Thresholds and Entrances

i. Individual Unit Entrances in Multi-Family Buildings and Townhouses

- » Individual front yard treatments should create a residential streetscape character and provide privacy for adjacent units. This can be achieved through grade changes, landscape, setbacks, a low wall or other treatment to provide a separation between public and private space.
- » Ensure that an effective transition between public and private space is created. In general, a third of the front setback should create a transitional space that is designed as part of the public ROW, while the remaining two thirds should be designed as a private front yard.
- » A minimum of 50% soft landscape should be provided within the front setback area for the width of the residential frontage.
- » The finished ground floor elevation should be a maximum of 1.5 metres (7-8 steps) above established grade.
- » Front porches are encouraged, as long as they do not extend into the “no encroachment” area. Front porches may project a maximum of 2.5 metres.
- » Individual units at the base of a larger building should be designed to complement the overall building, and should provide sufficient access to natural lighting and privacy.

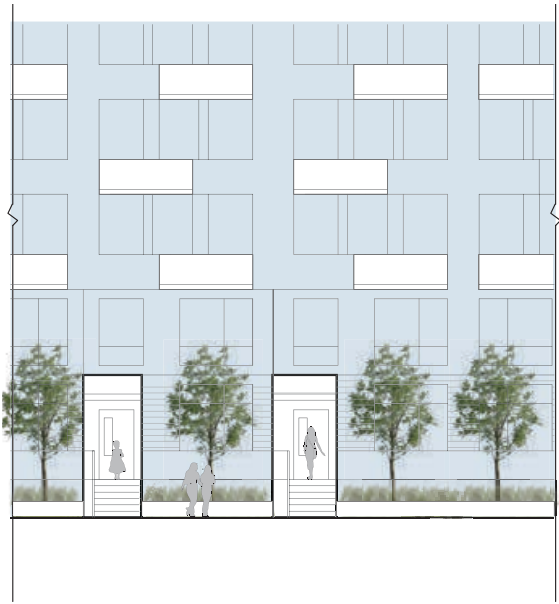

Elevation of residential individual unit entrance threshold.

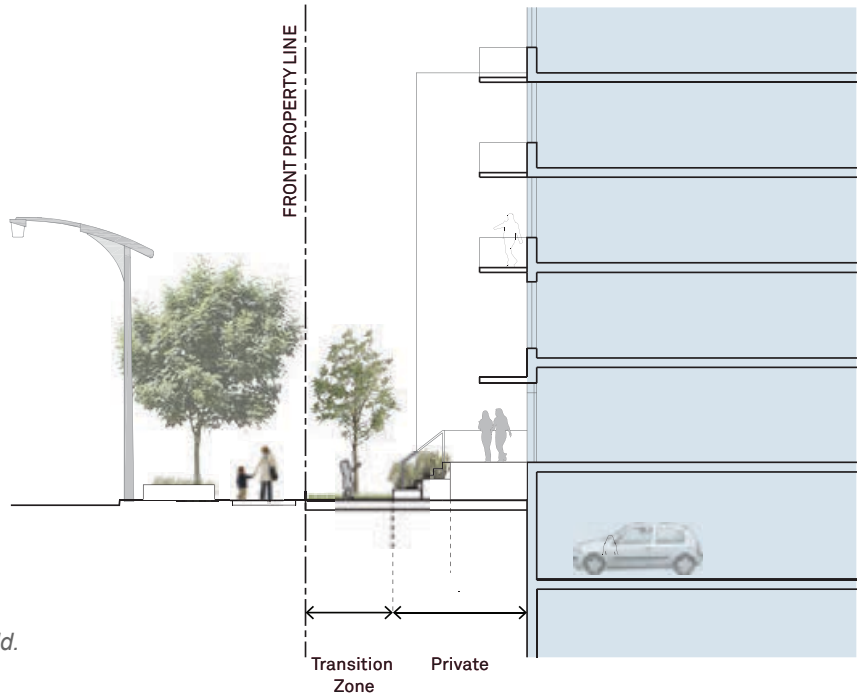

Section of residential individual unit entrance threshold.

SECTION 5



Landscape, a low wall and a grade change establish a transition to private space from the public sidewalk. (Image Credit: Brook McIlroy)



Individual townhouse units at the base of a Mid-Rise building establish privacy and provide natural light for the unit. (Image Credit: Brook McIlroy)

Performance Standard No. 5.3.8 (continued)

Thresholds and Entrances

j. Commercial Entrances (in stand-alone or mixed-use buildings)

- » Ground floor commercial units should include visible commercial signage, significant glazing and pedestrian amenities.
 - » Direct entrances should be provided from the primary street to retail units or commercial buildings.
 - » Grade changes should be avoided from the public sidewalk into ground floor commercial or office uses.
 - » Create ground floor retail units that vary in size and width.
 - » Commercial buildings may include spill-out spaces to complement indoor uses and provide seating or gathering areas.
- » Passive seating areas should include a combination of landscape and hard surfaces, as well as seating that has some weather protection or shade.
 - » Active spill-out spaces may be predominantly hardscaped with seating or commercial displays.
 - » Amenity spaces and signage should not infringe on the accessibility of the public streetscape, including the pedestrian clearway.
 - » Consider double height floors.
 - » A minimum of 15% soft landscape should be provided within the front setback area for the width of the commercial frontage.



Elevation of commercial individual unit entrance threshold with ample glazing.

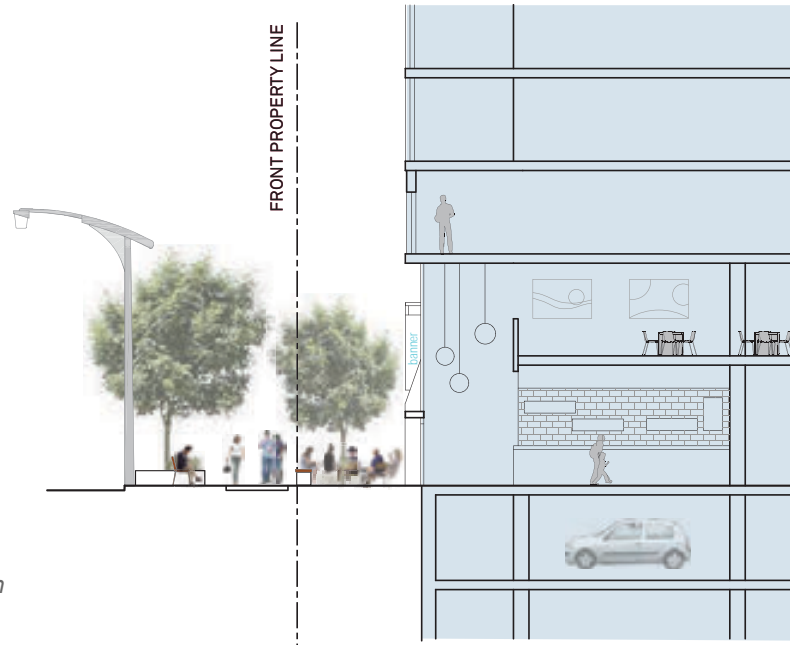

Section of commercial individual unit entrance threshold with a double height elevation at grade for retail flexibility.

SECTION 5

SPILL-OUT SPACE TO ACTIVATE THE CORNER



An active spill-out space at the corner provides a seating area to complement indoor uses. (Image Credit: Brook McIlroy)

SIGNAGE IS VISIBLE BEHIND LANDSCAPE

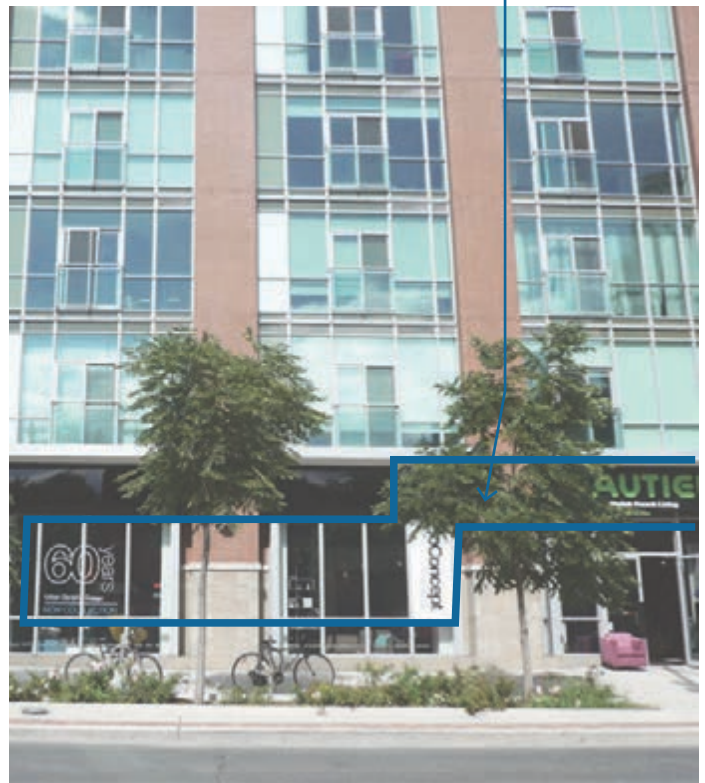

Landscape and tree planting retains visibility of commercial signage. (Image Credit: Brook McIlroy)

Performance Standard No. 5.3.8 (continued)

Thresholds and Entrances

k. Large Format Retail

- » Active, usable front entrances should be provided, addressing the primary public street with significant glazing into interior spaces.
- » Building facades should be articulated to provide visual interest.
- » Streetscape amenities should be provided along the front facade, including cycling and pedestrian furnishings.
- » A minimum of 15% soft landscape should be provided within the front setback area.



Elevation of large format commercial entrance threshold.

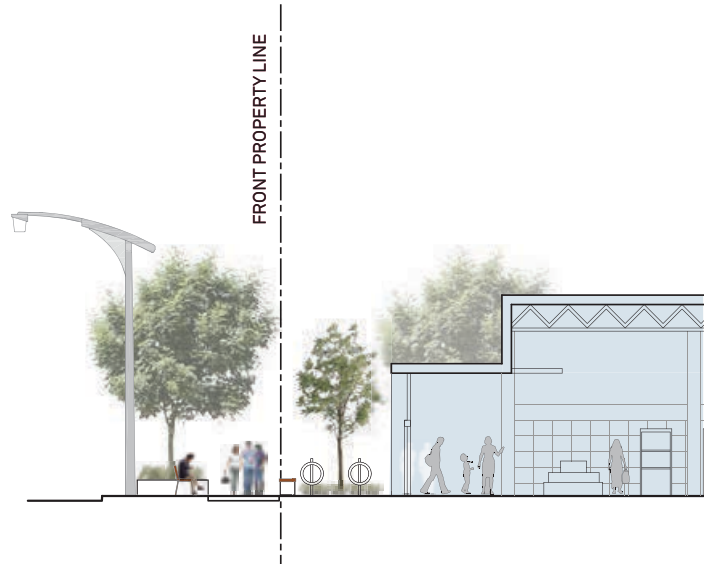

Section of large format commercial entrance threshold.

SECTION 5



Facade articulation with windows into the interior, combined with pedestrian amenities and landscape creates an interesting and pedestrian friendly facade. (Image Credit: Brook McIlroy)



An active usable entrance facing a well-landscaped street. (Image Credit: Brook McIlroy)

Performance Standard No. 5.3.9

Facade Design and Materials

Facades should be designed to create visual interest. This can be achieved through a combination of step-backs, articulation and use of materials.

- a. All building faces addressing the public realm or public spaces should have a consistent high quality of design and materiality. Townhouse clusters should consider views from other nearby townhouses and provide a high quality of facade design on side and rear faces.
- b. A variety of architectural styles is encouraged along the streetscape; however, within a single building, a consistent style, consistent elements and consistent materials should be used.
- c. Large blank facades are discouraged, and should not be permitted facing the public realm.
- d. Functional building elements, like vents and utilities, are encouraged to be consolidated, integrated into the building design, or screened from view.
- e. Balconies should be considered as an integral part of building design.
- f. Materials and articulation should be used to create a vertical and/or horizontal rhythm along the facade.
- g. Preferred cladding materials include brick, stone, metal, glass, or clay or concrete tile.
- h. The use of glazing should be balanced to provide natural light as well as improving energy efficiency. Higher levels of glazing are encouraged on the ground level to promote transparency, visibility, and passive observation of the street.
- i. Facade design and materials should respond to solar orientation.
- j. Selection of building materials should consider life-cycle costing and embodied energy. Recycled building materials should be used and new materials should be locally sourced.
- k. Operable windows should be installed in all building areas to allow for natural ventilation.



Distinct materials are used to create horizontal and vertical building components. (260 Sackville Street. Image Credit: Brook McIlroy)

- ① Building Face
- ② Articulated Facade (Projections or Setbacks)
- ③ Ground Floor Design



Significant glazing at the ground levels should be balanced with other materials on the upper levels. (Image Credit: 60 Richmond Housing Co-op, Teeple Architects)

Key guidelines:

- Performance Standard 5.3.8 Thresholds and Entrances
- Performance Standard 5.3.13 Bird Friendly Design

Performance Standard No. 5.3.10 Roof Design

Roof design should reduce the visual impact of mechanical equipment, provide usable space on the roof where appropriate and have a positive environmental impact.

- a. Rooftop mechanical equipment should be screened from view from public spaces using complementary building materials, parapets or other architectural devices, or by stepping the equipment back from the main building face below a minimum of 3 metres.
- b. Mechanical penthouses may be wrapped with residential units and amenity spaces.
- c. Rooftop decorative lighting is discouraged.
- d. Flat roofs and terraces are encouraged to be used as private outdoor or common amenity space for multi-unit residential buildings.
- e. Green roofs are strongly encouraged on all building types, covering roof areas not occupied by mechanical equipment.
- f. Green roofs may be combined with accessible amenity spaces.
- g. Where green roofs are not used, cool roof surfaces with a solar reflective index of 78 or higher for low-sloped roofs and 29 or higher for steep roofs should be used for all areas not occupied by mechanical equipment.
- h. Consider the use of rooftops for food production.

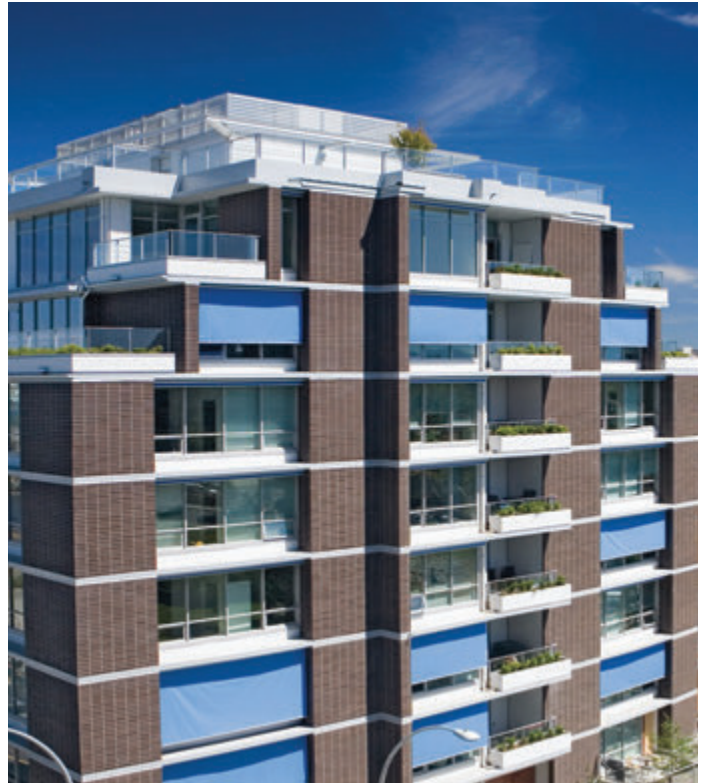

Well-screened rooftop mechanical equipment. (Image Credit: Dockside Green, Perkins+Will Architects)

Key guidelines:

- Performance Standard 5.2.2 Micro-Climate and Sky View
- Performance Standard 6.2.3 Rooftop Amenity Spaces

Performance Standard No. 5.3.11 Building Signage

Building signage should contribute to establishing a sense of place and enhancing the character of the building facade. It should contribute to pedestrian scale and ambiance, while clearly communicating its message.

- a. Signage should be simple, coordinated, and be designed and located to reduce visual clutter.
- b. Signage should be designed and mounted to complement the overall architecture of the building, while not obstructing architectural details. Where possible, signage can be integrated into the landscape design.
- c. Signage should be located in close proximity to building entrances.
- d. Down lighting may be incorporated to increase visibility of signage at night.
- e. Neon or other glowing or internally reflective signs are discouraged.
- f. In heritage areas, consult the HCD Plan for guidance on signage design and placement.
- g. Commercial signage should not overwhelm the appearance of the streetscape nor restrict the placement of street trees.
- h. Pylon or freestanding signs should use high quality components and coating, have structural integrity, and should be resistant to water, road salt and wind.
- i. The design of pylon or freestanding signs should be simple with a solid background, employ



Simple commercial building signage designed and mounted to complement overall building architecture. (Image Credit: Brook McIlroy)

complimentary colours and high contrast for legibility, and include the building address.

- j. Limit the number of commercial wall signs to one sign per business per elevation.

Key guideline:

- Performance Standard 5.2.13 Site Signage and Wayfinding

Key policy reference:

- City of Vaughan Sign By-law

Performance Standard No. 5.3.12 Building Lighting

Building lighting should provide safety and visibility while reducing light pollution and emphasizing dark sky and energy efficient lighting.

- a. Building lighting should be located at primary and secondary entrances, stairways and the access to underground parking.
- b. Use fully shielded lights that only emit light downward to reduce glare and light trespass, as well as for for better visibility at night.
- c. Lighting affixed to the building should only be located at the ground level, as it should only provide lighting for pedestrian areas.
- d. Light fixtures should complement the building's overall architectural character and materiality.
- e. Use the lowest wattage bulb possible for the task.
- f. Exterior lighting should be mitigated by shielding, so that light projects downward rather than skyward. Avoid creating "pools" of light that could attract birds, especially during inclement weather.
- g. Interior light should be mitigated by shutting lights off from 11:00 p.m. to 6:00 a.m.
- h. In parking structures, use occupancy sensors on 66% of fixtures while maintaining a minimum illumination level of 10 lux.



Downlighting integrated into a building entrance. (Image Credit: One Park West, Core Architects, Inc.)

Key guideline:

- Performance Standard 5.2.15 Site Lighting

Performance Standard No. 5.3.13 Bird Friendly Design

New buildings will consider birds through the treatment of glazing, landscape and lighting to reduce the incidence of bird strikes and create an urban environment in which birds can thrive.

- a. Integrate a combination of bird friendly treatments into building design to minimize window collisions, e.g., applying visual patterns on glass, incorporating opaque material, closed-space window mullions, decorative grills and exterior shades, glass that is angled downward, and reduced night sky lighting.
- b. Bird friendly treatments should be applied on 85% of contiguous glass area greater than 2 square metres and within the first 16 metres of the building above grade (or above a green roof).
- c. The remaining 15% of glazed windows do not need to be treated unless the glazing is larger than 2 square metres or is in close proximity to open spaces, a green roof or natural heritage features, where there are likely to be more birds.
- d. The untreated glazed windows (the remaining 15%) within 16 metres of ground level should:
 - » Avoid planting trees where they would reflect clearly in untreated glass.
 - » Locate trees and vegetation within 1 metre from glass areas or further than 30 metres from glass areas.
 - » Minimize the use of vegetation that bears fruit and attracts birds adjacent to highly reflective glass.
- e. To avoid fly-through conditions where clear glass corners meet, glass corners should be treated for 2.5 metres extending on each side away from the corner.
 - » Place low shrubs and groundcover adjacent to highly reflective glass.



Treated glass to prevent bird strikes. (Image Credit: 60 Howard Park Ave, Toronto, RAW Design. Photo courtesy of Walker Textures)

Key guidelines:

- Performance Standard 5.3.9 Facade Design and Materials
- Performance Standard 5.3.12 Building Lighting

Key policy reference:

- Technical Volume 2, Bird Friendly Guidelines

Performance Standard No. 5.3.14

Building Elements

Balconies

For residential buildings, balconies should be integrated into the overall building design. The balconies should have a positive impact on building massing, the public realm and the building's micro-climate.

- a. Balconies should be designed to extend interior living space. They should be of a usable shape and size, relative to unit size.
- b. Inset balconies are preferred as they reduce the visual impact of overall massing, while adding visual interest to the building facade.
- c. Where glass balconies are used, they should be treated to be bird-friendly for the first 16 metres. A mix of materials is encouraged.
- d. The design of balconies should consider the building's energy performance to reduce thermal bridging and manage solar gain.
- e. Consider building orientation, sunlight penetration, wind direction, acoustic and visual privacy in the selection of balcony type (eg. recessed, cantilevered or partially recessed balconies).



Inset balconies reduce the visual bulk of the building and provide interest to building massing. (66 Portland Street, . Image Credit: truelofts.ca)

Sheltered Pedestrian Areas with Overhangs

Sheltered pedestrian areas with overhangs should provide weather protection while creating a well-scaled and framed street and public realm interface.

- a. Overhangs should be designed as part of the overall building.
- b. Overhangs should be designed to provide a feeling of openness, enlargement of the public realm and visibility, using well-scaled and distanced support columns, building materials and height above grade.
- c. Overhang support columns should not impede movement along the pedestrian clearway and should be spaced to allow for light penetration into interior spaces.
- d. Overhangs should be designed to mitigate wind effects for pedestrians.
- e. Columns should be spaced a minimum of 2.5 metres apart and overhangs should be a minimum of 5 metres deep to maximize opportunities for weather protected outdoor amenity space.



A colonnade that extends the public realm with well-scaled columns that are integrated into the building design. (Image Credit: Brook McIlroy)

Key guidelines:

- Performance Standard 5.3.8 Thresholds and Entrances
- Performance Standards 5.3.2-4 Building Envelope

Section 6: **LANDSCAPE TYPOLOGIES**

6.1

Approach to Landscape Design

Vaughan's urban fabric is shaped by its parks, natural features and open spaces. The Performance Standards in this Section provide guidance for the design of a wide range of landscape typologies that will extend and connect the City's existing natural spaces.

Natural heritage features are strong defining character for the City and contribute to its overall identity and the quality of life for its residents. They are connected and complemented by a range of public open spaces, privately owned open spaces, site edges and amenity spaces.

This section provides guidance on how privately owned open spaces should be designed to extend a

robust and visible landscape character throughout the City. These recommendations define the hierarchy of anticipated private open spaces and identify key design goals for each typology.

All landscaped spaces on private property will be maintained by the property owner to meet the Performance Standards in this section.

Performance Standard No. 6.1.1

The Green Approach

The Green Approach focuses on creating a network of green spaces, edges and buffers that collectively reconnect and enhance the City's existing natural systems while increasing the tree canopy.

Tree Planting

- a. Landscape design should prioritize provision of soil volumes to support mature tree growth to help achieve York Region's urban tree canopy goal for the City of 25-35%.
- b. On-site trees are a key City asset and should be retained wherever possible. Where this is not possible, re-planting should follow the guidelines set out in the City of Vaughan Tree Replacement Plan.
- c. Overall tree health in open spaces should be monitored and a tree succession plan created to ensure the long-term viability of the tree canopy.
- d. Trees can be used to create a distinct pattern and identity for the street or site through the use of species that flower, provide a variation in textures, or give fall colour.

Key guidelines:

- Performance Standard 6.1.2 The Green Approach on Intensification Corridors
- Performance Standards 5.3.2-4 Building Envelope

- e. Consult the Vaughan Forestry Department to review plans and ensure conformance with current City forestry policy.
- f. Plant larger caliper trees wherever possible.

Key Dimensions:

- g. All trees must have access to a minimum of 30 cubic metres of soil (20 cubic metres each for trees with shared soil volume).
- h. Trees should be spaced 8 to 10 metres (6 to 10 metres for small form species) apart parallel to the property line, depending upon the species of tree and site conditions.
- i. Site planning should seek to maximize continuous soil areas for tree planting and vegetation. Soil cell technology may be necessary to achieve required soil volumes.

Site Landscape

- a. Select tree and plant species for the appropriate Hardiness Zone and consider climate conditions.
- b. Detailed design for planting and landscape typologies should consider all seasons.
- c. Sites should provide landscaped spaces that are of a sufficient size and shape to support the

Key policy references:

- York Region Forest Management Plan (November 2016)
- Ministry of the Environment and Climate Change Design Guidelines
- Technical Volume 2, Terms of Reference for Trees



Throughout the City of Vaughan, landscape should create a network of green spaces that provide a distinct green identity, contribute to meeting the City's tree canopy objectives and provide environmental benefits. (Image Credit: Chicago planting bed. Photo by Dan Wendt, MWRD)

- management of stormwater, absorption of noise and cooling of urban spaces.
- d. A combination of measures should be used to target removal of at least 80% of total suspended solids from all runoff leaving the site on an annual basis.
- e. Successful landscape-based stormwater management (or Low Impact Development) is dependent on a multi-level approach to managing storm water. Diversification of water flow options can help address the 100 year storm requirement and minimize the creation of duplicate systems.
- f. Minimizing stormwater runoff should be addressed in the landscape with a focus on Low Impact Development (L.I.D.) that increases infiltration and improves water quality. Implementation of L.I.D. measures should be based on an analysis of soil types and potential for infiltration, as well as topography, visibility, etc.
- g. Irrigation plans should avoid the use of potable water and rely on passive irrigation.
- h. Accessibility should rank highly among landscape design objectives.
- i. All landscape plans near natural heritage areas should use non-invasive or drought tolerant planting.
- j. Native planting is encouraged throughout the City to promote biodiversity, distinguish the regional landscape character and promote low input planting strategies.
- k. Plant material that supports a diverse and ecologically sustainable environment is recommended. Planting should be selected to provide habitats for birds, bees and butterflies and to promote biodiversity. Planting should be low-maintenance and salt-resistant.



Planting should promote biodiversity, a distinct identity for the street and habitats for bees, butterflies and birds. (Image Credit: West End Commons by David Baker + Partners. Photo by Cesar Rubio)



Incorporate L.I.D. measures into site landscape design to manage stormwater on-site. (Image Credit: Brook McIlroy)

- l. Hardscaped areas should consider materials that allow for water infiltration to minimize runoff. Permeable paving is not considered to be soft landscape.
- m. Where permeable paving is utilized, an annual maintenance regime must be articulated and followed in perpetuity.
- n. Consider the use of landscaped space in residential developments for gardens and food production.
- o. Consider utility locations when planning on-site tree and planting plans.
- p. Utility rights of way should be adhered to for all tree planting on private sites.
- q. Planting as buffers for wind, visual screening and privacy are recommended where applicable.
- r. Planting and hedges should not limit the safety, visibility or sense of security of a pedestrian, cyclist or driver.

- s. Landscaped setbacks should transition seamlessly to the Regional boulevard treatments by choosing complimentary materials and ensuring that grading does not create any trip hazards.
- t. Grading should prevent stormwater runoff into the public realm.

Key Dimension:

- u. The use of raised planters to accommodate soil volume is discouraged. The maximum height for planters should be 0.5 metres to accommodate seating. Planters should be located so as to not impede vehicular site lines.

Performance Standard No. 6.1.2

The Green Approach On Intensification Corridors

To achieve a Green Approach on Intensification Corridors additional design standards are provided to ensure consistency within the street frontage for all land uses. The increased front yard setback should provide sufficient space to accommodate a double row of trees, stormwater management gardens and other environmental functions.

- a. Low-Impact Development measures should be integrated into the Green Approach Zone. A combination of mechanisms can be used, including bio-swales and permeable paving, as long as they function to filter and infiltrate stormwater.
- b. Smaller stature trees should be planted where they are located underneath a building cantilever, medium stature trees should be planted where they are close to the building face and large

stature trees should be planted where they are further from the building face.

- c. Amenities like bicycle racks and benches are encouraged within the Green Approach Zone on Intensification Corridors.
- d. Where there are townhouses or residential units at-grade, the Green Approach Zone should consist of a minimum 60% soft landscape.
- e. Where there are retail uses, lobbies or common amenity spaces at-grade, the Green Approach Zone should consist of a minimum 15% soft landscape.
- f. Setbacks on intensification corridors provide an opportunity to connect green infrastructure. The role of the setback within the larger context should be defined in the context analysis mapping.
- g. Underground parking may not project beyond the building footprint within the Green Approach Zone on Intensification Corridors. This is to ensure that sufficient soil volumes can be provided to support mature tree growth and water infiltration, as well as minimizing disturbance to landscaped areas through maintenance of parking structures over time.

Key guidelines:

- Performance Standard 5.3.1 Buildings on Intensification Corridors
- Performance Standard 5.3.2-4 Building Envelope

Performance Standard No. 6.1.2 (continued) The Green Approach On Intensification Corridors



Townhouse units with front yard landscape including stormwater retention areas and tree planting. (Image Credit: Nevue Ngan)



A commercial building with a wide landscaped Green Approach Zone. (Image Credit: Brook McIlroy)



A minimum of 60% soft landscape should be provided where there are townhouses at-grade, and a minimum of 15% soft landscape should be provided where there are commercial uses at-grade.

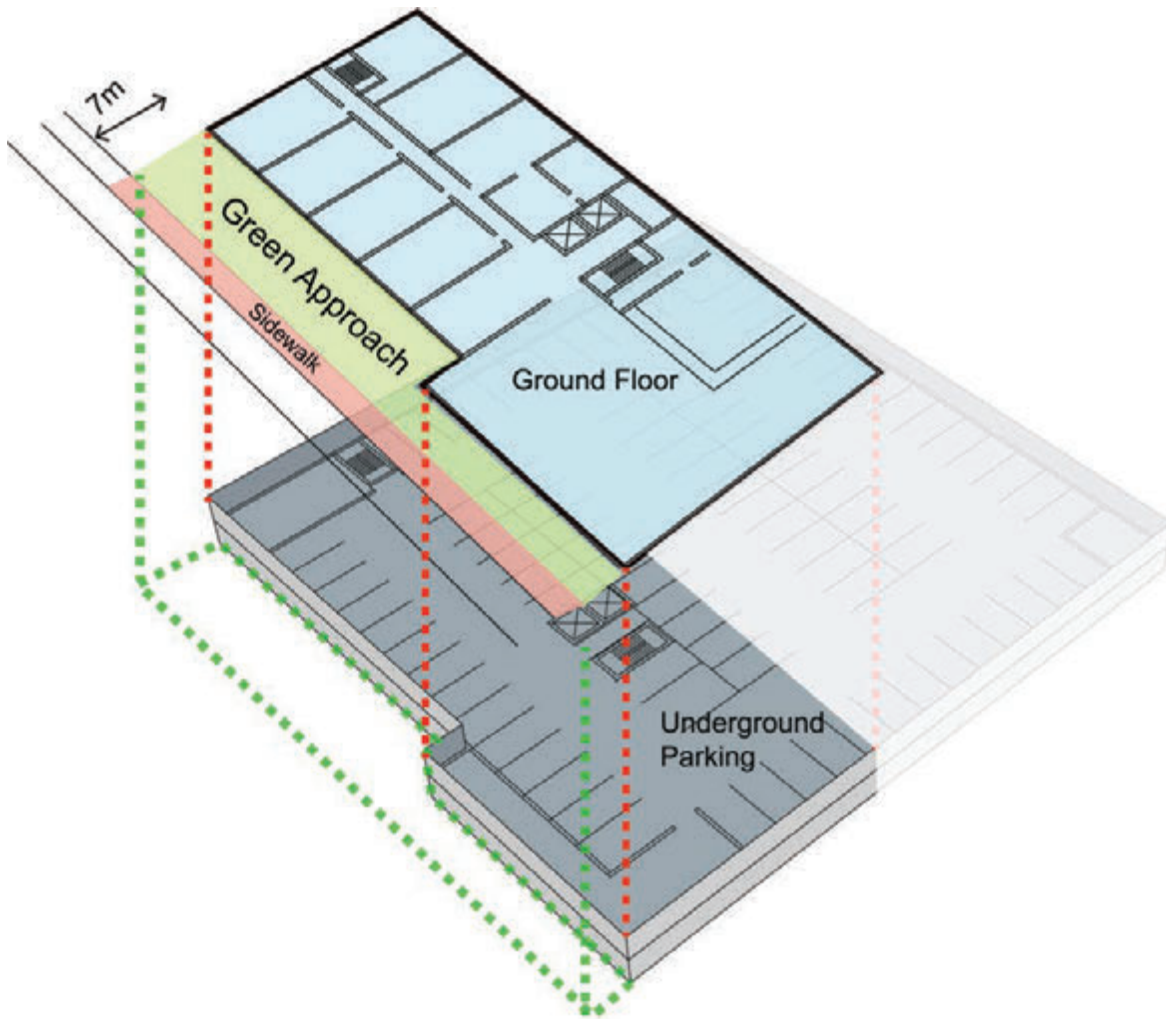

Underground parking may not project beyond the building footprint into the Green Approach Zone (front yard setback) on Intensification Corridors.

Key Dimensions:

- h. Trees should establish a consistent streetscape pattern to minimize transitions between properties. Where possible, a continuous row of trees should be planted at 1.5 metres from the front property line. Where space permits, a second row of trees should be planted approximately 4 metres from the front property line.
- i. Porches or front entrance landings associated with at-grade townhouse units may project into the Green Approach a maximum of 2.5 metres.

6.2 Common Amenity Spaces

Performance Standard No. 6.2.1 General Guidelines for Common Amenity Space

Common Amenity Spaces are open spaces that can be private, semi-private or public. These spaces can be grade-related or on rooftops and should be designed to contribute to quality of life for the building's residents and users.

- a. A minimum of 50% of the required amenity space should be outdoor amenity space for all forms of residential development.
- b. Amenity spaces in residential developments should be programmed to provide multiple functions and uses for all ages, all year round. Programming can include gardens, water features, plazas, seating or picnic areas, children's play areas, outdoor kitchens and barbeques, etc.
- c. Outdoor amenity spaces should be co-located with the building's indoor amenity spaces to create a larger community gathering space.
- d. Amenity spaces should be highly visible from within the building or other outdoor spaces to enhance the feeling of safety.



Play spaces should be framed by local roads, buildings and pathways and should be safely accessible from all townhouse units. (Image Credit: Brook McIlroy)

- e. Ensure open spaces are comfortable with ample access to sunlight, as well as shaded areas and weather protection. Protection from wind will be a key factor in making the outdoor environment more comfortable in the winter.
- f. Amenity spaces should be designed to allow for winter maintenance.
- g. Children's play areas are preferred in grade-related amenity spaces rather than rooftops.

Key Dimensions:

- h. Townhouse developments with more than 20 units or without access to nearby open space based on the context analysis should provide a minimum 2.6% GLA as outdoor amenity space. Amenity spaces should be consolidated into areas that are a minimum of 250 m².

Key guideline/policy reference:

- Performance Standards 6.2.2-8
- City of Vaughan Official Plan, Chapter 9

Performance Standard No. 6.2.2 Private Grade-Related Amenity Spaces + Courtyards

Grade related amenity spaces can provide unique common open spaces for building users. They should have a mix of hard and soft landscapes.

- a. Amenity spaces should be directly connected to building entrances when associated with a multi-family residential building.
- b. In a condominium townhouse development, amenity spaces should be centrally located and accessible by all units.
- c. Amenity spaces should be framed by local streets, buildings, pathways and landscape.
- d. Where amenity spaces are built over below-grade parking:
 - » The location of tree planting should consider the maintenance requirements of below grade parking areas to avoid removing trees to repair or maintain the parking structure.
 - » A minimum depth of 1.6 metres of soil above the structure should be provided to allow for sufficient depth for soil cells and paving.
- e. Fenced amenity spaces should not be accessible from the public street and should be entered from private properties.
- f. Grade-related amenity spaces should be located away from busy public streets and parking areas.
- g. Amenity spaces may include urban agricultural plots, community gardens or fruit trees.
- h. The provision of amenity spaces should be informed by a local deficiency or limited access to local outdoor amenities.



Multiple uses should be provided in amenity areas, including community gardens. (Image Credit: healthyork)

Key guideline

- Performance Standard 6.2.1 General Guidelines for Common Amenity Spaces

Performance Standard No. 6.2.3

Rooftop Amenity Spaces

Well designed rooftop amenity spaces further City-wide sustainability goals, provide unique urban experiences and create essential community gathering spaces within an urbanizing context. The design and character of rooftop amenity space should be an extension of the building design and its interior uses.

- a. Rooftop amenity spaces should be located and designed to minimize wind exposure and maximize sun exposure. Use wind screens and canopies where required to mitigate wind exposure.
- b. Mechanical equipment on rooftops should be located away from amenity areas, with screening or buffering to reduce noise and visibility.
- c. Integrate green roofs to provide naturalized amenity space and reduce the urban heat island effect.
- d. Plant material and screens should be used to provide visual dividers between programmatic areas and between private unit areas and common outdoor spaces.
- e. Plant material should be durable and suitable for rooftop areas, including the potential for high wind or extreme cold. Planting areas on rooftop terraces often require irrigation.
- f. Incorporate bird-friendly glazing adjacent to green roofs or where there is significant landscape.

- g. Orient amenity areas to provide a balance of sun and shade for family oriented residential developments.
- h. Incorporate children's play areas into rooftop amenity spaces if it is not possible to locate them in grade-related amenity spaces.

Key Dimension:

- i. The minimum depth of a rooftop amenity space should be no less than 10 metres, and the width to depth ratio should not exceed 4:1.

Key guidelines:

- Performance Standard 5.3.10 Roof Design
- Performance Standard 6.2.1 General Guidelines for Common Amenity Spaces

Key policy references:

- City of Vaughan Official Plan, Chapter 9



Rooftop amenity space consisting of seating and hard and soft landscape. (19th District Housing Complex, Warsaw, Poland. Image Credit: JEMS Architects)

Performance Standard No. 6.2.4 Internalized Courtyards

Courtyards provide a mix of soft and hard landscape spaces, with passive programming. They are typically located at the side or back of buildings and are well framed by buildings on at least three sides.

- a. Courtyards should be connected to active indoor uses, including lobbies and indoor amenity spaces, providing an extension of indoor space.
- b. Publicly accessible courtyards should generally not be located directly adjacent to grade-level residential space. If this is the case, entrances to residential spaces should not open directly onto the courtyard.
- c. Incorporate passive programming like pathways and seating. Active programming may also be considered, like a children's play area.
- d. Building courtyards should provide balanced areas of sunlight and shade.
- e. Ensure that courtyards are designed to feel like publicly usable space. This can be achieved through significant transparency so that the courtyard can be viewed through the building, or through pathways leading from the public street to the courtyard.
- f. Ensure that bird-friendly treatment is used on buildings near any courtyards.
- g. Ensure that courtyards have sufficient access to sunlight.



A building courtyard provides a passive amenity space for employees. (Image Credit: Brook McIlroy)

Key Dimensions:

- h. The minimum courtyard width should be no less than 15 metres, and the width to depth ratio should not exceed 4:1.

Key guideline/policy references:

- Performance Standard 6.2.1 General Guidelines for Common Amenity Spaces
- City of Vaughan Active Together Master Plan 2013

Performance Standard No. 6.2.5 Urban Squares

Urban squares, including plazas, are publicly accessible, predominantly hardscaped areas located between the building face and the street. The design of plazas should be consistent with the overall character and vision of the development but should also be in keeping with the streetscape design.

- a. Urban squares are generally located in front of primary building entrances to provide additional prominence to the entrance.
- b. Features within the plaza/forecourt should not visually or physically obstruct the entrance.
- c. Urban squares should have a defined character and should include unique paving, landscape, seating, lighting and shade trees or structures.
- d. The design and character of the plaza should respond to local culture or history.
- e. Urban squares should be designed as extensions of the indoor spaces that frame them. This can be done with large amounts of glazing, complementary ground floor uses or material continuity.
- f. Opportunities to animate these spaces in the winter should be investigated, including seasonal events or skating.

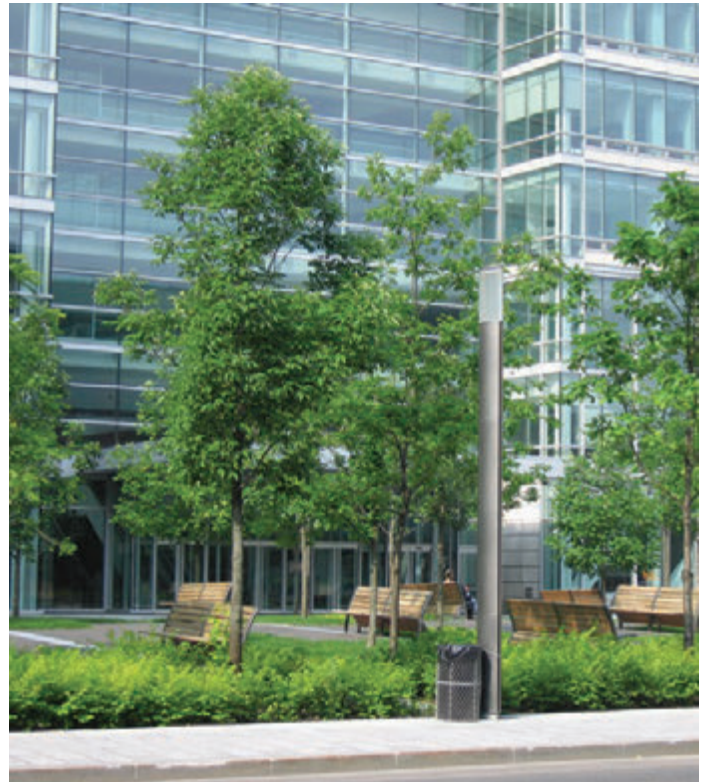

*Plazas with seating, landscape and tree planting for shade.
(Image Credit: Brook McIlroy)*

Performance Standard No. 6.2.5 (continued)

Urban Squares

- g. Urban squares are fundamentally flexible spaces that can accommodate a range of potential uses such as gatherings, events, retail spill out spaces, patios, etc.
- h. Large urban squares or consecutive plazas (across a number of properties) should have a cohesive design that allows for continued pedestrian movement throughout the space.
- i. Some urban squares and plazas may be considered as potential privately owned publicly accessible amenity spaces. This would be determined through consultation with City Staff.
- j. The location and orientation of urban squares should maximize sunlight with southern exposure and mitigate wind impacts.
- k. Urban squares should be connected to the public realm and lined with active uses. They should be constructed at grade and have access to public sidewalks on at least one side.

Key Dimension:

- l. Plazas and urban squares typically have a width to depth ratio that ranges from 1:3 to 1:1.

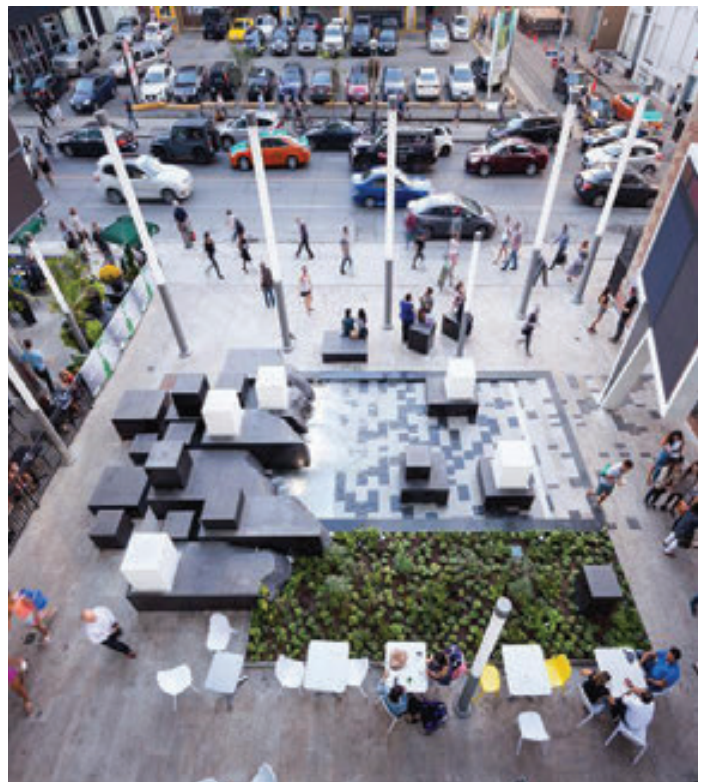

Plaza in an active urban centre with seating, a water feature, vegetation and urban lighting features. (Image Credit: Janet Rosenberg & Studio. Photo by Jeff McNeill)

Key guideline:

- Performance Standard 6.2.1 General Guidelines for Common Amenity Spaces

Key policy reference:

- City of Vaughan Active Together Master Plan 2013

Performance Standard No. 6.2.6 Gardens

Gardens are an important contributor to the overall health of our urban ecosystem. These types of spaces can provide essential opportunities for growing food and provide habitat for bees, butterflies and birds.

- a. Gardens should be located in ideal growing locations that consider the micro-climate of the building, including shadows, wind, etc.
- b. Gardens may be planted on rooftops.
- c. Opportunities to provide community gardens or pollinator gardens throughout new development are strongly encouraged.
- d. Opportunities for community gardening partnerships should be considered.
- e. On projects with extensive gardens, consider working with a consulting agronomist to create ideal soil conditions.
- f. Developers should consider hiring a consulting garden/agriculture specialist to educate residents about urban agriculture.
- g. Gardens should incorporate seating. They may also include signage elements to identify plants, or explain the purpose of the garden and its larger role in the area's ecosystem.
- h. Ensure that bird-friendly treatment is used on buildings near any gardens.

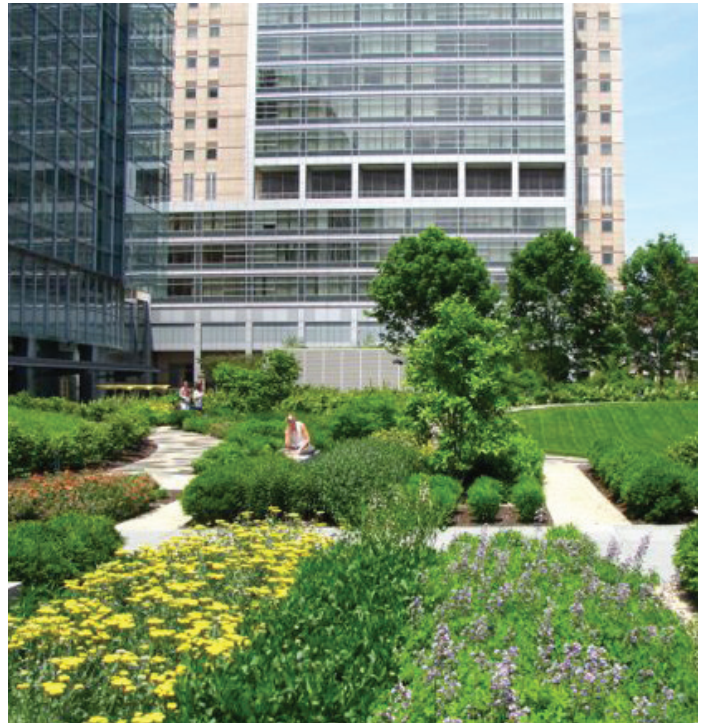

A rooftop garden provides an amenity space in an institutional building. (Image Credit: Buerger Centre, Nelson Byrd Woltz Landscape Architects)

Key guideline:

- Performance Standard 6.2.1 General Guidelines for Common Amenity Spaces

Key policy reference:

- City of Vaughan Official Plan, Chapters 7 and 9

Performance Standard No. 6.2.7

Publicly Accessible Interiors

Publicly accessible interiors are indoor transitional building spaces that provide sheltered open space. These spaces should be designed for casual gathering, informal meals, meeting places, sitting and centralized building circulation.

- a. Publicly accessible interiors are typically found in residential, employment or institutional buildings that invite the public to use the building.
- b. To be well-used, publicly accessible interiors should be centrally located, publicly visible and accessible, and provide at least two exits for circulation.
- c. Publicly accessible interiors are characterized by an abundance of light, an airy open feeling and a mix of park-like and circulation spaces.
- d. Locate and orient publicly accessible interiors to take advantage of passive heating and natural light.
- e. Where possible, atrium spaces or publicly accessible interiors should be framed by the active uses on the ground floor and upper levels facing onto the atrium space.
- f. Centralized circulation elements like escalators, stairs and elevators may be incorporated as design features.
- g. Indoor planting features should be included in atrium spaces to contribute to air quality and character.
- h. Ensure that bird-friendly treatment is used on buildings with publicly accessible interiors.
- i. The design of sites should promote seamless transitions between open space and interior atriums where the Publicly Accessible Interiors may be located.



Atriums should provide an abundance of natural light and an airy open feeling. (Image Credit: Dyson Campus by Wilkinson Eyre Architects)

Key guidelines:

- Performance Standard 5.3.8 Thresholds and Entrances
- Performance Standard 6.2.1 General Guidelines for Common Amenity Spaces

Performance Standard No. 6.2.8

Privately Owned Publicly-Accessible Spaces (POPS)

Privately-owned public spaces (POPS) are extensions of the surrounding community fabric. Though not designated as parkland, POPS are desirable spaces that add to the City's supply of gathering spaces and landscape amenities. They should be designed to be welcoming, universally accessible, visually open and flexible to accommodate a range of programmatic uses. POPS must be designated through an agreement with the City.

- a. POPS should be publicly accessible to the entire community and serve an overall neighbourhood function by providing a gathering, resting, event or passive recreation space at strategic locations or interfaces.
- b. POPS may be framed by buildings, other open space or public streets.
- c. POPS should provide adequate signage specifying that they are open to the public.
- d. POPS should be designed to seamlessly transition from public to private space without significant changes in material, grade, or visual barriers that may imply that the space is private.
- e. POPS may be located adjacent to retail spill-out spaces or patios associated with commercial units, but these uses should not be located within the POPS unless they are publicly accessible without purchase.
- f. Materials and landscape should be of a similar or higher standard to that of the abutting street or open areas.
- g. Amenities for cycling (including parking and potentially bike repair) should be integrated into all grade-level POPS.
- h. Incorporate L.I.D. features into POPS wherever possible to capture, detain, infiltrate and clean stormwater.
- i. To maintain sight lines and a full visibility of the open space, high canopy trees are recommended.
- j. To be considered for a POPS, an open space must at a minimum achieve the majority of the following requirements:
 - Located in a prominent, public facing location.
 - Provides a critical site connection that benefits the surrounding community.
 - Fulfills a required open space need that has been identified for the development or the surrounding community.
 - An integral part of the surrounding public realm design and / or landscape treatments.
 - The main entrances of future development is located off of the POPS as a mid-block connection.



POPS provide publicly accessible gathering spaces to the community that include green landscapes and tree planting. (Image Credit: Raymond and Susan Brochstein Pavilion, Office of James Burnett. Photo by Hester & Hardaway Photographers)

- k. The City may require a public access easement, but operations and maintenance responsibility will fall on developer or condominium corporation.

Key guidelines:

- Performance Standard 5.2.11 Mid-Block Connections/Mews
- Performance Standard 6.2.1 General Guidelines for Common Amenity Spaces

Section 7: **BUILDING USES**

7.1

Introduction

A range of building uses are located throughout the City of Vaughan. This section includes general Performance Standards that provide a vision for each building use.

Additional Site and Building Performance Standards can be found in Section 5.

Building uses include:

1. Mixed-Use Buildings
2. Residential Multi-Family Buildings
 - Apartment Buildings
 - Townhouses
3. Retail/Commercial
 - Urban Format Retail
 - Gas Stations
 - Drive-Throughs
4. Community Facilities
 - Institutional Buildings
 - Places of Worship
5. Employment
 - General Employment
 - Prestige Employment
 - Corporate Campus

7.2 Mixed-Use Buildings

Performance Standard No. 7.2.1 Mixed-Use Buildings

Mixed-use buildings support many of the policy and city-building objectives of the City of Vaughan, including contributing to urban intensification at a human scale, active transportation, diversity of housing options and a greater mix of uses. A range of typologies, including Low-Rise, Mid-Rise and High-Rise buildings can support mixed-use development. These building standards are discussed in Section 5.

- a. Commercial uses at the ground level should have individual unit entrances accessed directly from the street. Upper level residential units - or office units, in the case of live/work buildings - may be accessed from a shared lobby entrance.
- b. In general, ground floors should be a minimum of 4.5 metres in height and building systems should be designed to accommodate a range of uses over time. If a continuous streetwall has already been established, new buildings should align with existing ground floor height and design.
- c. Building entrances should avoid grade changes from the public sidewalk to ensure that grade level retail, office and commercial units and upper level residential units can be accessed by all.
- d. A significant amount of glazing should be provided within the ground floor and lower

building levels to permit views of indoor uses, create visual interest for pedestrians and contribute to passive observation of the street.

- e. Both indoor and outdoor bicycle parking should be provided for building residents and visitors.
- f. The majority of vehicular parking should be provided underground. Surface parking should be limited to convenience parking at the rear of the building for retail uses.
- g. Private balconies should be provided for residential use on upper levels where there is adequate sunlight and opportunity for views into the City's natural heritage, landmarks or skyline.
- h. Balconies should be inset within the primary facade instead of projecting wherever possible.
- i. Common amenity spaces should provide multiple uses and functional spaces for people of all ages, including children. They should be designed to read as distinct from the public realm but accessible to all building residents.

Key Dimensions:

- j. Except where otherwise directed, setbacks from public streets should provide 3.5-7 metres of active space between the street and the building face for streetscape amenities, like benches, pedestrian lighting and bicycle parking, landscape and spill-out spaces.
- k. Balconies should have a minimum depth of 1.5 metres, in order to be functional.



Encourage diverse community living mixed-use buildings with residential, retail and office uses. (Image Credit: Crossroads Vancouver. Photo courtesy of Leducor Group)

Key guideline/policy references:

- Performance Standards 5.2.3-5 Parking
- Performance Standard 5.2.6 Servicing, Storage Areas and Loading
- Performance Standards 5.3.2-4 Building Envelope
- Performance Standard 5.3.8 Thresholds and Entrances
- Performance Standard 5.3.14 Building Elements

Key policy reference:

- Sustainability Site Plan Metrics, No. 12, 13 & 14

7.3 Multi-Family Residential Buildings

Performance Standard No. 7.3.1 Apartment Buildings

Residential apartment, condominium, and rental buildings provide a range of at-grade and upper level housing options. Their design should promote landscaped residential streetscapes and provide an effective transition between public space and private units. A range of typologies, including townhouse, Mid-Rise and High-Rise buildings can support apartment-style development. These building standards are discussed in Section 5.

- a. Residential apartment buildings may include units that are accessed by a shared entrance and internal corridors, or a mix of grade-level townhouse units with individual entrances and upper level apartment-style units.
- b. Buildings should be designed to provide fully accessible units and building entrances.
- c. Appropriate setbacks from the public right-of-way, as outlined in the relevant Building Design Performance Standards, should be provided to create a feeling of separation and privacy for building residents. Generous landscape including tree planting should be provided.
- d. Both indoor and outdoor bicycle parking should be provided for building residents and visitors.
- e. Common amenity spaces should provide multiple uses and functional spaces for people of all ages, including children. They should be designed to read as distinct from the public realm but accessible to all building residents.
- f. Where townhouse-style units are provided at the ground floor, they should be designed and expressed as individual units through the use of materials and facade articulation.
- g. Private balconies should be provided for residential uses on upper levels and these should be integrated into building design. Front porches may be provided for grade level townhouse units. Micro-climate conditions should be considered in locating balconies.
- h. Residential apartment buildings should provide a range of unit sizes, including family-sized units of three bedrooms or more.



Multi-family residential building combining individual townhouse units at-grade with apartment style units above. (Image Credit: The Erikson, Steven Ballegeer)

Key guidelines:

- Performance Standards 5.2.3-5 Parking
- Performance Standard 5.2.6 Servicing, Storage Areas and Loading
- Performance Standards 5.3.2 & 5.3.3 High-Rise and Mid-Rise Building Envelope
- Performance Standard 5.3.8 Thresholds and Entrances
- Performance Standard 5.3.14 Building Elements

- Sustainability Site Plan Metrics, No. 12, 13 & 14
- Performance Standard 5.3.5 Townhouse Design
- Performance Standard 6.2.1 General Guidelines for Common Amenity Spaces

Key policy reference:

- Sustainability Site Plan Metrics, No. 6, 7 & 12.

Performance Standard No. 7.3.2

Townhouses

Townhouses are an important part of the “missing middle” of housing typologies between Low- and High-Rise buildings.

They should: be compatible in design with existing neighbourhoods, create residential streetscapes, contribute to the overall greening of the City, and provide usable amenity spaces.

- a. Townhouses should create residential streetscapes with individual building entrances and elements like front yard landscapes, tree planting, and porches to reflect the character of established neighbourhoods in Vaughan.
- b. Units should be of an appropriate size and depth to ensure access to natural light throughout the unit.
- c. The visual dominance of parking should be reduced, by locating parking in rear garages accessed by a laneway, locating parking underground or minimizing the width of integrated garages within the front facade. Where surface parking is provided, it should be located to the rear of buildings or be visually screened from the public realm.
- d. Common amenity spaces should provide multiple uses and functional spaces for people of all ages, including children. They should be designed to read as distinct from the public realm but accessible to all building residents.
- e. Landscaped spaces should be consolidated to create spaces that are of an adequate size and shape that they provide environmental and visual benefits.
- f. Townhouses should be designed to ensure that a generous front yard landscape can be accommodated and soil volumes can support mature tree growth.
- g. Townhouses should provide a high level of facade treatment on all building facades that are visible from the public realm, adjacent buildings or other townhouse groupings.
- h. End townhouse units adjacent to a flanking street should provide a building entrance and primary facade addressing both the flanking and primary street.
- i. Utility infrastructure for each unit should be consolidated and located at the side or rear of the building, or incorporated into the building where possible.
- j. Rooftop amenity spaces are encouraged as usable common amenity space.

Key Dimensions:

- k. Common amenity spaces should be aggregated into areas no less than 50m² with a width to depth ratio no greater than 4:1. A minimum of 5.2 m² of common amenity space or 10m² for stacked townhouses should be provided per dwelling unit.



Townhouses with well-landscaped front yards creating privacy and private balconies and rooftop patios providing ample amenity space. (Image Credit: 83 Redpath, Sweeney & Co Architects)

Key guidelines:

- Performance Standards 5.2.3-5 Parking
- Performance Standard 5.2.6 Servicing, Storage Areas and Loading
- Performance Standard 5.3.5 Townhouse Design
- Performance Standard 5.3.8 Thresholds and Entrances
- Performance Standard 6.2.1 General Guidelines for Common Amenity Spaces
- Urban Design Guidelines for Infill Development in Established Low-Rise Residential Neighbourhoods

7.4 Commercial Buildings

Performance Standard No. 7.4.1 General Guidelines for Commercial Buildings

Commercial buildings provide the residents of Vaughan with critical goods and services within the community, whether in single buildings along main streets or clustered within large format development sites. These sites should encourage transit use, active transportation and vibrant street life, and they should frame public spaces and streets with active uses.

- a. On large sites, commercial developments should be integrated into a consistent pattern of streets and blocks.
- b. Developments should incorporate a variety of retail unit sizes and building formats.
- c. Commercial buildings should contribute to active and vibrant streetscapes by locating primary entrances to address public streets, visually connecting interior uses with exterior uses through glazing and spill-out spaces, and providing landscape and pedestrian and cycling amenities, including bike parking.
- d. Buildings should front onto public streets or internal streets created on the site.
- e. Where buildings face both a public street and an internal parking area, the preference is that primary entrances should be provided on both frontages. At a minimum, both facades are required to be predominantly glazed with visual connections between the interior of the retail unit and the street. Where fronting onto both sides is not possible, allow for one row of parking between the building and the public road, and provide frontage there.
- f. Continuous boulevards should be provided along commercial building frontages that connect to streets, parking areas, courtyards or other gathering spaces.
- g. Clearly demarcate pedestrian circulation areas and design these to have priority over vehicular circulation areas.
- h. Consider providing lay-by parking to provide access to commercial units for short-term visitors and to buffer boulevards from traffic.
- i. Open spaces between commercial buildings, street edges and parking areas should be well landscaped.
- j. Excessive signage and illumination are discouraged. All signage should follow the regulations in the City of Vaughan Sign By-Law.
- k. Minimize the number and width of vehicular access points and circulation routes.
- l. Within retail districts, incorporate outdoor seating, gathering spaces, pedestrian lighting and other amenities to create a vibrant and urban character.



Buildings framing streets in a commercial district to create active pedestrian streets and offer visibility to businesses.

Key guidelines:

- Performance Standard 4.3.1 Streets and Blocks
- Performance Standards 5.2.3-5 Parking
- Performance Standard 5.2.6 Servicing, Storage Areas and Loading
- Performance Standards 5.3.2-4 Building Envelope
- Performance Standard 5.3.8 Thresholds and Entrances
- Performance Standard 5.3.11 Building Signage

Performance Standard No. 7.4.2

Urban Format Retail

Urban format retail sites contribute to the diversity of commercial space in Vaughan. Finer grained units in intensification areas, that provide a more urban type and density of commercial use, promote pedestrian access and permeability.

- a. The location of smaller format stores should be used to define street edges, courtyards, terraces and other public open spaces.
- b. Multi-storey buildings are encouraged to maximize site area and increase the density of commercial uses.
- c. The co-location or close proximity of small format stores, narrow facades and the coordinated alignment of entrance doors is encouraged to facilitate sequential shopping on foot.
- d. Areas not required for servicing between buildings should be well landscaped and programmed.
- e. Small format stores should have continuous pedestrian sidewalks on all sides of the building where public entrances and parking areas are located.
- f. Pedestrian amenities should be provided in commercial developments including pathways that connect parking areas to entries, seating and human scaled lighting.
- g. Commercial signage should be integrated with the building's architecture.
- h. Cycling amenities should be provided in commercial developments, including outdoor parking for customers, indoor parking for employees, and other optional amenities.

Large Urban Format Retail

- i. Larger urban format retail sites should be highly permeable and provide easy and comfortable access for transit users, pedestrians and cyclists.
- j. Primary entrances should be provided from public streets, and facades should be designed to incorporate pedestrian amenities, such as vibrant display windows, landscape, benches, public art and pedestrian scaled lighting.
- k. Surface parking should be located to the rear of buildings or internally to the site.
- l. Long facades should incorporate architectural relief and detailing, entrance features, display windows, recesses and projections along their length.
- m. Consider incorporating smaller retail units or multiple entrances on longer facades to provide interest and multiple destinations.
- n. False upper floors are discouraged. All floors visible from the street should be functional.
- o. False glazing (spandrels) is discouraged.



Large format retail uses in an urban format, including mixed-uses and articulated facade. (Image Credit: 421 Brant Street by Turner Fleischer Architects)

Key guidelines:

- Performance Standard 4.3.1 Streets and Blocks
- Performance Standards 5.2.3-5 Parking
- Performance Standard 5.2.6 Servicing, Storage Areas and Loading
- Performance Standard 5.3.1 Buildings on Intensification Corridors
- Performance Standards 5.3.2-4 Building Envelope
- Performance Standard 5.3.8 Thresholds and Entrances
- Performance Standard 5.3.11 Building Signage

Performance Standard No. 7.4.3

Gas Stations

The design of gas stations should prioritize the character of the public realm and facilitate pedestrian movement while providing the necessary services.

- a. Accessory convenience commercial buildings should be located adjacent to the arterial street or use low walls or landscaped areas to frame public streets and spaces. When located on a corner lot, built form and landscape design should frame both streets.
- b. Materials and facade design should be of a high quality.
- c. Building form and location should ensure that there is adequate space in stacking lanes to accommodate a sufficient number of vehicles to avoid spillover onto the public street or on-site circulation areas.
- d. Direct pedestrian connections should be provided from the street to the building. Pedestrians should not have to cross stacking lanes to enter the building.
- e. Plant landscaped buffers at property edges, ensuring that sightlines are maintained and pedestrian areas are visible.
- f. Canopies should be provided over fueling areas.
- g. Where a car wash or automotive workshop is provided as part of the site, it should be located away from the property line, while providing sufficient space for vehicle stacking and landscape.
- h. Complementary building materials should be used for the primary building and the car wash or accessory building.
- i. Noise- and light-generating areas should be located away from sensitive uses and screened or buffered through the use of landscape.
- j. All garbage areas should be enclosed in the main building. Stand-alone garbage structures are discouraged.
- k. Signage should be built into the site's landscape elements or integrated into the building's architecture.
- l. Site design that includes a patio or outdoor seating areas should provide a buffer to separate the vehicular circulation areas. Patios should provide clear pedestrian connections to the building entrance and the street.

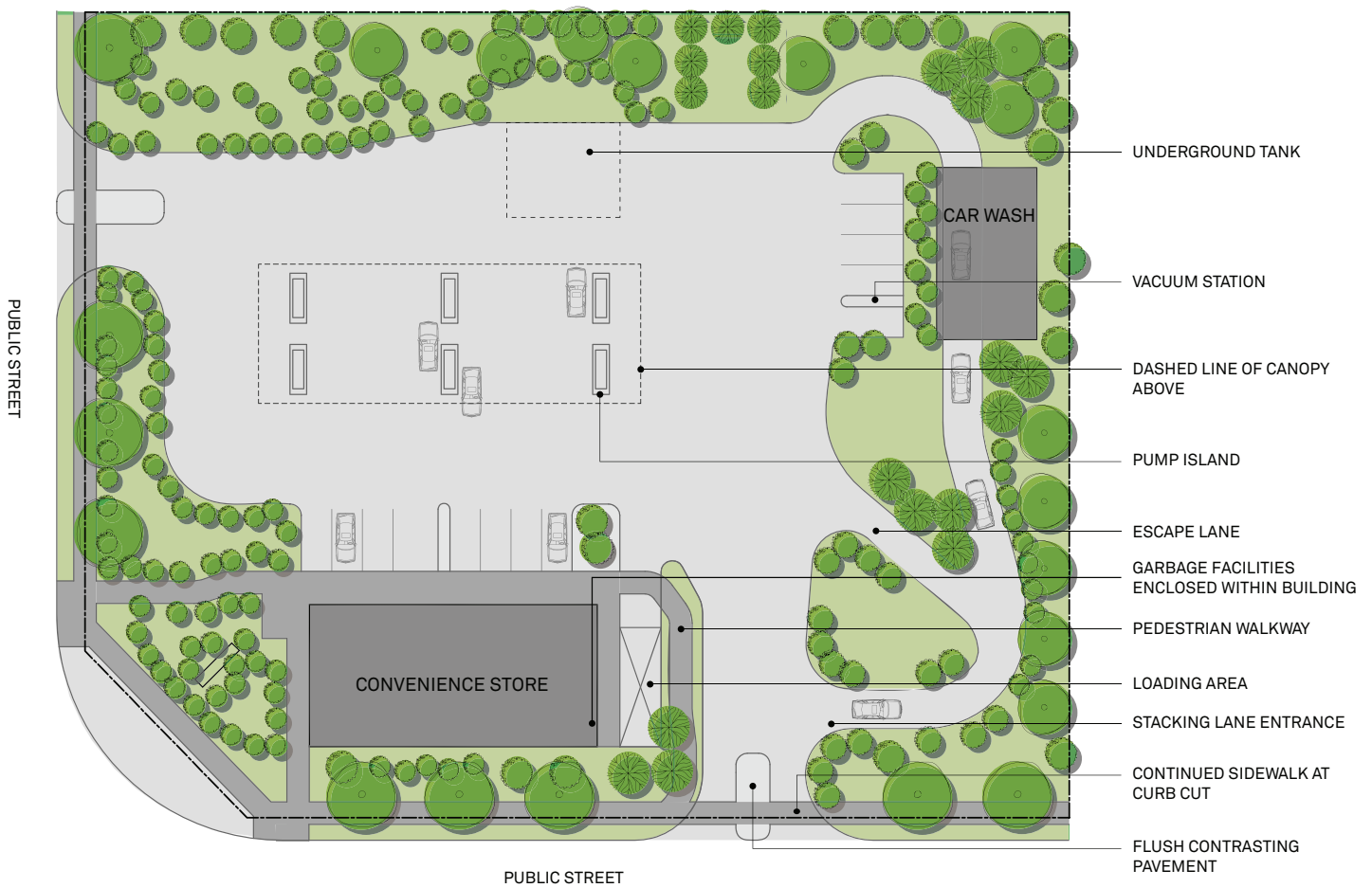

SECTION 7

Corner site layout for auto-related uses.

Key guidelines:

- Performance Standard 4.3.1 Streets and Blocks
- Performance Standard 5.2.3 Surface Parking
- Performance Standard 5.3.8 Thresholds and Entrances
- Performance Standard 5.3.9 Facade Design and Materials
- Performance Standard 5.3.11 Building Signage

Key policy reference:

- City of Vaughan Official Plan, Chapter 5

Performance Standard No. 7.4.4 Drive-Through

Drive-through facilities provide convenient services to residents. Their design and location should not take away from the connectivity of the public realm or interrupt pedestrian, cyclist or vehicle travel.

- a. Drive-through buildings should be located near the street edge with pedestrian entrances located on primary frontages and directly accessible from public streets.
- b. Ensure that pedestrians do not have to cross stacking lanes to enter the building.
- c. Glazing should be used to create a visual connection from the street to the building interior.
- d. Parking and vehicular access should be located at the rear of the site. Avoid locating stacking lanes between the building and the street.
- e. Building facades should utilize high quality and durable materials on all sides of the building.
- f. Locate servicing and loading areas internally to the site, away from the street frontages and to avoid conflicts with on-site circulation. These areas should be screened from view from primary streets and pedestrian pathways.
- g. Architecturally integrate pick-up windows into the building design. Multiple service windows in a single stacking lane should be implemented to reduce idling and congestion.
- h. Consider locating outdoor seating areas near the main entrance and away from vehicular circulation areas.
- i. Ensure that there is adequate space in the stacking lane to accommodate a sufficient number of vehicles to avoid spillover onto the public street or on-site circulation areas. Where the site area is constrained, double stacking lanes may be provided to reduce the length of the line.
- j. Plant landscaped buffers at property edges, ensuring that sightlines are maintained and pedestrian areas are visible.
- k. Noise- and light-generating areas should be located away from sensitive uses and screened or buffered through the use of landscape. Illuminated signage should be context sensitive.

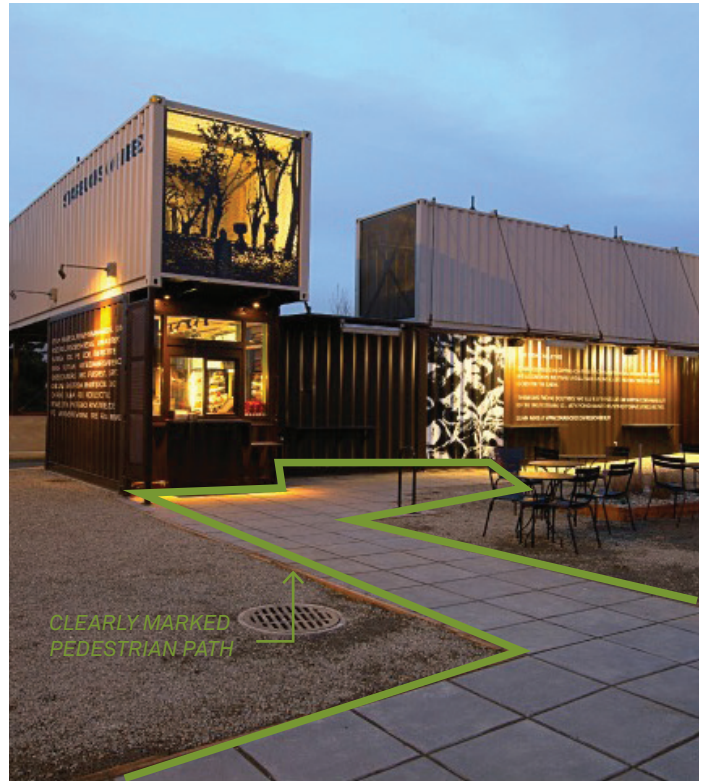

A Starbucks drive-through in Washington State provides safe pedestrian pathways to the building entrance, and locates vehicular access at the rear of the site. (Image Credit: Pinterest).

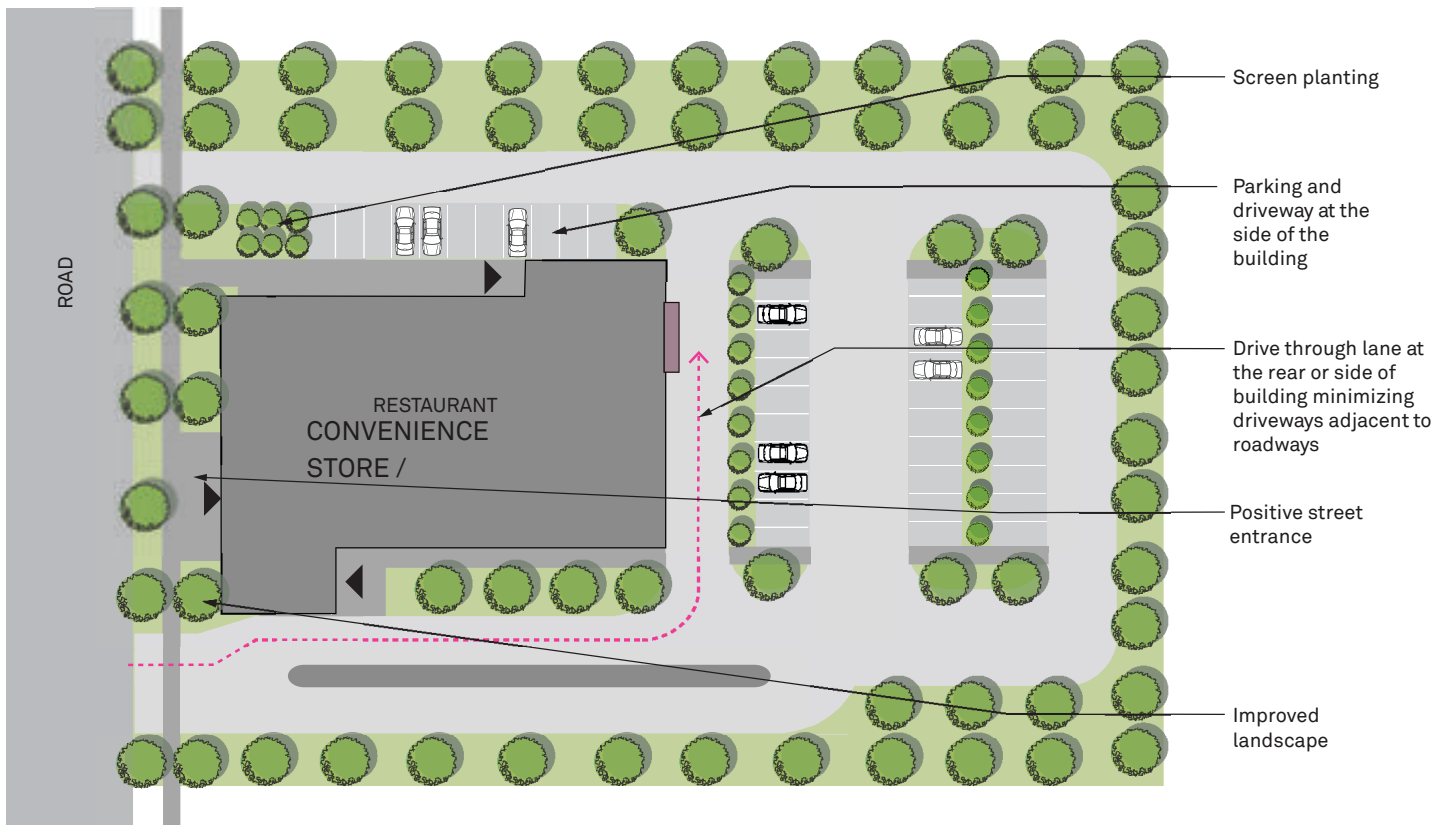

Example drive-through site layout.

Key guidelines:

- Performance Standard 4.3.1 Streets and Blocks
- Performance Standard 5.2.3 Surface Parking
- Performance Standard 5.2.6 Servicing, Storage Areas and Loading
- Performance Standard 5.2.12 Pedestrian and Cycling Connections and Street Furnishings

- Performance Standard 5.2.15 Site Lighting
- Performance Standard 5.3.8 Thresholds and Entrances
- Performance Standard 5.3.9 Facade Design and Materials

Key policy reference:

- City of Vaughan Official Plan, Policy 5.2.3.10

7.5 Community Facilities

Performance Standard No. 7.5.1 General Guidelines for Community Facilities

Community facilities play an important role in civic life, and are often the heart of community activities and social events for all ages, abilities and cultures.

They should be designed as an extension of the public realm and should reflect best practices in sustainability and accessibility.

These facilities include institutional buildings, which should reflect their civic importance, and places of worship, which should function as focal points within the community.

a. The scale of community facilities should fit within their context, including site scale and size, adjacent land uses and surrounding building types.



Access through active transportation should be emphasized and complementary outdoor spaces should be provided. (Image Credit: Grimsby Public Library, Shore Tilbe Irwin + Partners)

- b. In dense urban settings and Intensification Areas, parking should be provided underground or in a structured facility, with the exception of convenience parking and short-term drop-off and pick-up areas.
- c. In stable areas or lower density areas, well-designed surface parking with landscaped buffers framing the street, clear pedestrian pathways to the building entrances and landscaped islands throughout the parking area may be appropriate.
- d. Where provided, surface parking should be located to the rear of buildings. It should be designed with generous landscape, L.I.D. measures and tree planting to contribute to the City's overall canopy.
- e. Access to community facilities through active transportation should be emphasized, with



Institutional buildings should be designed to reflect their civic importance, with a prominent entrance, transparency between indoor and outdoor space and associated outdoor spaces. (Image Credit: Regent Park Aquatic Centre. Photo by Shai Gil)



Maximize the use of operable windows to naturally illuminate interior spaces. Provide outdoor seating, trees and landscape to compliment interior programming with outdoor gathering and amenity spaces. (Image Credit: Vaughan Civic Centre Resource Library by ZAS Architects + Interiors. Photo by Doublespace Photography)

Performance Standard No. 7.5.1 (continued)

General Guidelines for Community Facilities

direct pedestrian connections from transit stops, cycling access and bicycle parking provided near building entrances.

- f. Community facilities should be designed as landmark buildings, with prominent building features and public spaces.
- g. Full accessibility should be provided throughout community sites and buildings.
- h. Wherever possible, community facilities, schools and parks should be located near each other and provide safe, accessible active transit connections between them.
- i. Design public buildings to be solar ready.
- j. Community facilities are good locations for prominent public art features.

Institutional Buildings

- k. Multi-storey buildings are encouraged to maximize site area and make efficient use of services, as well as to contribute to walkability and provide a sense of enclosure for the street.
- l. Buildings should strive for LEED Gold or higher, or an equivalent standard of sustainability.
- m. Building design should emphasize prominent entrances, connected with outdoor plazas, forecourts or gathering areas, with weather protection and significant transparency.
- n. Provide outdoor seating, trees and landscape to complement interior programming with outdoor gathering and amenity spaces.
- o. Complementary outdoor spaces should be located adjacent to active indoor spaces.
- p. Sustainability and L.I.D. measures or pilot projects are encouraged as part of community

facilities. Where these are provided, consider providing educational or informative signage.

- q. Maximize the use of operable windows to naturally illuminate classrooms, offices, recreational and social spaces.
- r. Covered pathways or building edge colonnades are recommended to link separate buildings or to provide weather protected building edges, waiting areas and gathering spaces.

Places of Worship

- s. Places of worship should be positioned as focal points within the community and should be well connected to neighbourhoods and public amenities.
- t. Places of worship should be easily accessible by all modes of movement.
- u. On corner sites, places of worship should address both streets with a primary frontage.
- v. Places of worship may be set back from the street to create a gathering area or forecourt outside the main entrance.
- w. Parking should be located behind the building and main entrances should face the street.
- x. Office functions (active uses) should be designed and located to activate the street with windows and entrances on the front facade.
- y. When parking is located beside the building, it should be designed with appropriate landscape and buffering to minimize its appearance.
- z. The scale of places of worship should fit within the existing neighbourhood fabric and provide a visual amenity for all residents.



Woodbridge United Church. (Image Credit: Google Earth)



Batul Islam Mosque. (Image Credit: Hamid)

Key guidelines:

- Performance Standard 4.3.3 Landmarks and Views
- Performance Standard 5.2.2 Micro-Climate and Sky View
- Performance Standards 5.2.3-5 Parking
- Performance Standard 5.2.12 Pedestrian and Cycling Connections and Street Furnishings
- Performance Standard 5.3.11 Building Signage
- Performance Standard 5.3.14 Building Elements
- Performance Standard 6.2.1 General Guidelines for Common Amenity Space

Key policy reference:

- City of Vaughan Official Plan, Chapter 9

7.6 Employment Buildings

Performance Standard No. 7.6.1 General Guidelines for Employment Buildings

Buildings in Employment Areas may include a wide variety of forms and types, ranging from offices to warehouses and industrial buildings. All employment buildings should encourage access via active transportation and pedestrian friendly streetscapes. Site design should also take advantage of relatively large building sites to integrate generous landscape that acts as a public amenity and a buffer for functional and back-of-house uses.

As many of the Employment Areas within the City of Vaughan are adjacent to *Natural Areas* and *Countryside* uses, employment sites should provide a sensitive transition to natural areas and provide trail connections where appropriate. Architectural excellence and seamless design within the public realm are encouraged.

- a. Building and site design should promote access for pedestrians, cyclists and transit users.
- b. Create distinct and visible pedestrian entrances that are directly connected to the public street and do not cross parking areas.
- c. Multi-storey buildings are encouraged to maximize site area and make efficient use of services, as well as to contribute to walkability and provide a sense of enclosure to the street.
- d. Buildings should be designed to provide visual interest, with significant glazing, prominent entrances, facade articulation and high quality materials.
- e. Parking, servicing and loading functions should generally be located at the back of buildings, underground or screened from view from the public realm.
- f. Buildings should provide indoor and outdoor bicycle parking for visitors and employees.
- g. Small convenience parking areas for visitors may be permitted at the front of the building.
- h. Integrate comfortable, quiet and welcoming gathering areas for employees away from loading, storage or other noisy areas.
- i. Landscape should be used to provide multiple benefits such as visual buffering, improving air quality, reducing noise by absorbing sound and managing and filtering stormwater on site.
- j. Landscaped buffers should be provided between properties.
- k. Consolidate property access through shared driveways wherever possible to reduce the number of curb cuts and interruptions to the pedestrian realm. In some cases, it may be appropriate to provide separate driveway access for loading/



Buildings should provide visual interest and create distinct and visible pedestrian entrances. (Image Credit: KPMG Office Tower by Diamond and Schmidt. Photo by Brook McIlroy)

- servicing functions and employee/visitor access and parking.
- l. In Intensification Areas, parking should be provided underground or in a structured facility, with the exception of convenience parking and short-term drop-off and pick-up areas.
- m. In Employment Areas or other low density areas, well-designed surface parking may be appropriate.
- n. Primary building frontages should face streets and natural areas, while manufacturing and back-of-house uses should be located at the rear of the site or along shared lot lines.
- o. Rooftop mechanical should be screened from view.
- p. Street parking is encouraged.

Key guidelines:

- Performance Standard 4.3.1 Streets and Blocks
- Performance Standard 4.3.9 Development Adjacent to Highways
- Performance Standards 5.2.3-5 Parking
- Performance Standard 5.2.6 Servicing, Storage Areas and Loading
- Performance Standard 5.3.1 Buildings on

Intensification Corridors

- Performance Standards 5.3.2-4 Building Envelope
- Performance Standard 5.3.8 Thresholds and Entrances

Key policy reference:

- City of Vaughan Official Plan, Chapter 9

Performance Standard No. 7.6.2 Prestige Employment Buildings

Prestige Employment Buildings should provide a transition between main streets and corridors and General Employment Areas.

As highly visible sites, they should be designed as landmark buildings, with an urban character.

- a. Buildings should address all streets and adjacent public spaces with primary frontages and generous landscaped edges.
- b. Given their focal nature, prestige employment buildings should be designed as landmarks to capitalize on their high visibility and access to surrounding areas.
- c. Buildings should incorporate highly visible and transparent entrances, and may include forecourts or plazas.
- d. Parking should be provided underground for office uses and site design should encourage access by transit and active transportation.
- e. Utilize rooftops as green roofs or as amenity spaces for employees.
- f. Atriums, plazas, forecourts, pathways and courtyards are encouraged as part of site and building designs.
- g. Where surface parking is provided, it should be located to the rear of buildings or be visually screened from the public realm.

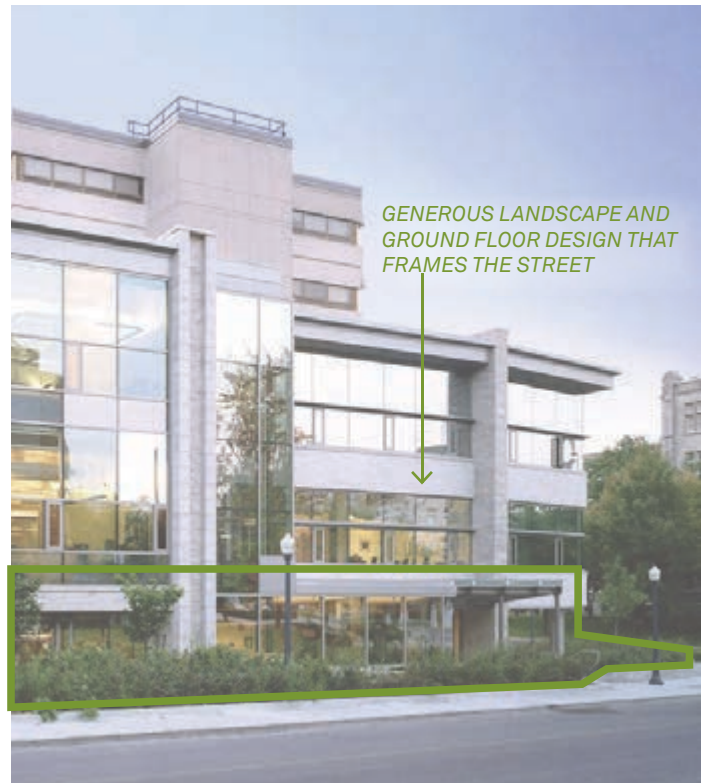

Prestige employment buildings should frame streets with generous landscape, which should include a combination of high quality hardscape and softscape treatment, and an urban character. (Image Credit: Beamish-Munro Hall, B+H Architects)

Key guidelines:

- Performance Standards 5.2.3-5 Parking
- Performance Standard 5.3.1 Buildings on Intensification Corridors
- Performance Standards 5.3.2-4 Building Envelope
- Performance Standard 5.3.8 Thresholds and Entrances

Key policy reference:

- City of Vaughan Official Plan, Chapter 9

Performance Standard No. 7.6.3 Internally Oriented Employment (Campus Style)

Campus-style office uses will be key hubs of office and employment activity. They should be designed to provide a balanced setting with well-connected buildings that frame major streets and internal public spaces.

- a. Indoor public and lobby spaces should be complemented by outdoor amenity spaces for use by employees, creating a vibrant character and sense of community.
- b. Integrate supportive mixed-use within office buildings, such as retail, restaurants, fitness facilities, day cares or other uses.
- c. An accessible and direct site circulation plan and active transportation access should be provided. Consider covered pathways or building edge colonnades to link buildings or provide weather protected circulation routes.
- d. Provide a coordinated and consistent system of wayfinding and signage. This system can act to provide a sense of place or distinct identity for the campus.
- e. Site design should delineate a well-defined system of driveways, pedestrian and cycling routes, parking areas and amenity spaces to minimize conflicts between modes.
- f. Utilize rooftops as green roofs or as amenity spaces for employees.
- g. Atriums, plazas, forecourts and courtyards are encouraged as part of site and building design.
- h. Entrances should connect to the public street as well as internal public spaces.



Corporate campuses should provide a balanced setting where buildings frame internal public spaces and circulation networks. (Image Credit: Vaughan City Hall, Kuwabara Payne McKenna Blumberg Architects)

Key guidelines:

- Performance Standards 5.3.2-4 Building Envelope
- Performance Standard 5.3.14 Building Elements
- Performance Standard 6.2.1 General Guidelines for Common Amenity Spaces

Key policy reference:

- City of Vaughan Official Plan, Chapters 5 and 9

Performance Standard No. 7.6.4 Employment/Industrial Buildings

Employment/Industrial Buildings in General Employment Areas should be located to frame public streets and reduce the visual impact of parking, servicing and loading functions. Large sites should create generous landscaped frontages and buffered edges, with connected and comfortable pedestrian networks.

- a. Buildings should address the street edge with a generous landscaped front setback.
- b. Warehouse, servicing and outdoor storage areas should be located at the rear of sites and should not be visible from the primary street. Screening, landscaped buffers or other measures may be considered. Screening methods should be particularly careful to screen outdoor storage from view of abutting public spaces.
- c. A small convenience parking lot may be located at or in front of the primary building facade. It should not take up a width of more than 50% of the width of the building or be more than one aisle of parking in depth.
- d. Building elevations facing public streets should incorporate architectural articulation to minimize the effects of blank walls.
- e. Industrial buildings should be designed with a consideration of high quality materials and visually interesting massing such as barn or barrel vault style roofs.



Industrial Building with generous landscape and reduced blank walls. (Image: Hallmark Poultry Processors, Google Maps)

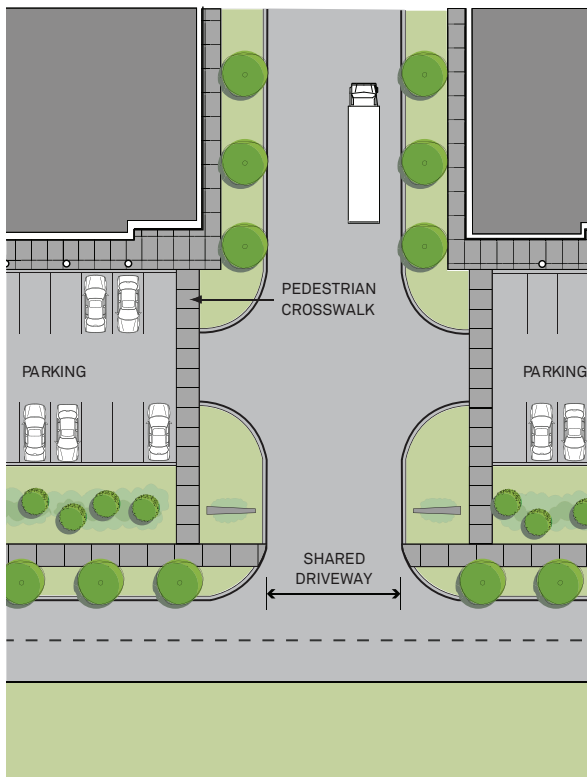

Sample surface parking plan for Employment/Industrial buildings.

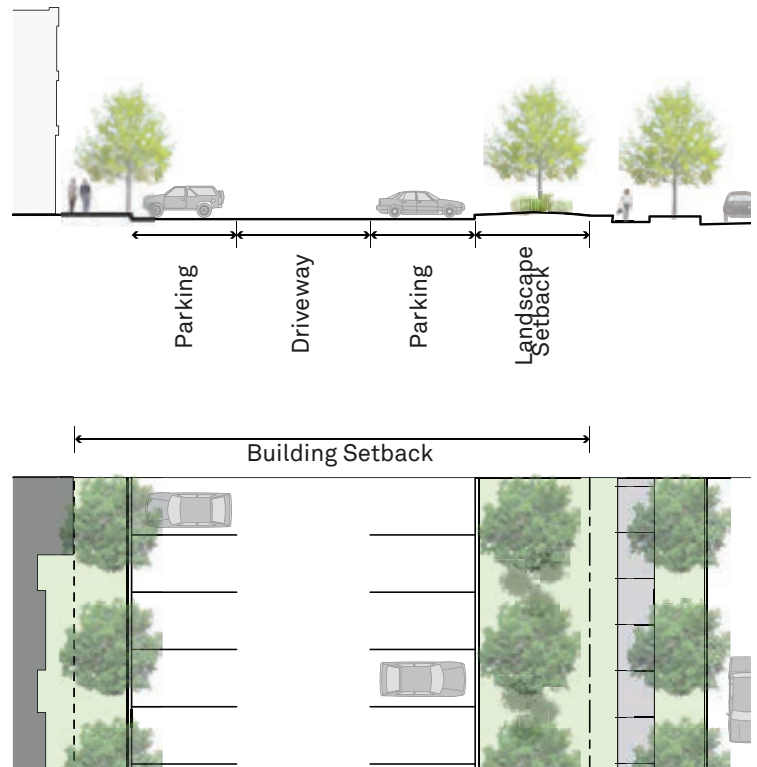

Sample surface parking plan for Employment/Industrial buildings.

Key guidelines:

- Performance Standard 4.3.9 Development Adjacent to Employment and Highways
- Performance Standards 5.2.3-5 Parking
- Performance Standard 5.2.6 Servicing, Storage Areas and Loading
- Performance Standard 5.2.10 Screening, Fencing and Low Walls
- Performance Standards 5.3.4 Low-Rise Building Envelope
- Performance Standard 5.3.8 Thresholds and Entrances

Key policy reference:

- City of Vaughan Official Plan, Chapters 7 and 9

Section 8: **PHASING**

8.1

Phasing Considerations

Applications for subdivision or site plan approval which propose to construct development in phases are required to include a phasing plan. The phasing plan should provide an overview of development elements (public and private) in text and graphics. The plan (which can be included as part of an Urban Design Brief) is an essential part of a development application. It provides certainty that the development will be realized as per the approvals process and ensures that a development is phased in such a manner that each stage of development is able to function and exist on its own. A phasing plan is not intended to lock in the design development of a building prematurely in the approvals process, but it is meant to articulate a clear urban and architectural design approach for the entire project and ensure that

the approvals process can proceed with a shared understanding between the developer/design team and City Staff.

The phasing plan should include drawings and text descriptions of the following components of the development to ensure that the overall character, function and fit of the planned community is in keeping with the surrounding conditions (existing and planned):

1. Introduction
 - a. Purpose of the Phasing Plan, scale, size and type of development.
 - b. Location and Context Plan (as per the City Wide Urban Design Guidelines)
 - c. Adjacencies and Transitions
 - d. Key Connections
 - e. Overview of Key Reference Documents
2. Development Vision and Design Approach
 - a. Urban Design Principles (as per the City Wide Urban Design Guidelines)
 - b. Concept Plan Overview
 - c. Structure Elements (for entire development)
 - i. Land-Uses
 - ii. Public Realm Plan (including semi-public areas)
 - iii. Public Open Spaces
 - iv. Mid-Block Connections
 - v. Semi-Private / Private Open Spaces
 - vi. Phasing of Municipal Servicing
 - vii. Phasing of Street and Block Connections
 - viii. Landscape Plan
 - ix. Public Art Plan
 - x. Parking Strategies
 - xi. xi. Cycling Circulation
 - xii. Pedestrian Circulation and Sidewalks
 - xiii. Building and Vehicular Entrances
 - xiv. Servicing and Loading
 - xv. Pedestrian Scaled Lighting
- d. Street Design
- e. Public and Private Spaces
- f. Phasing Plans and Timelines
 - i. Overview of each development phase including transitional uses, access, parking, massing, anticipated development typologies, etc.
3. 3Architectural Design Approach by Development Type
 - a. High Rise, Mid Rise, Low Rise Buildings, etc.

A phasing plan should be submitted concurrently with the first stage of an approvals process. This will allow staff to fully understand the anticipated vision for the area and assist the designers to identify any roadblocks to implement all phases of development.

Section 9: **CHECKLIST**

Checklist to come following approval of the City-Wide Urban Design Guidelines.

Appendix A: **GLOSSARY**

Glossary of Terms:

Active Ground Floor: Some amount of at-grade active uses, such as retail or commercial spaces, may enliven a streetscape, foster social interaction and bring eyes and safety over city spaces. Large, active and engaging store fronts, as well as patio and outdoor spill-outs, produce a finer grained rhythm of experiences for the pedestrian. Location, size and control over the amount of small retail that is permitted is essential for its economical viability.

Active Uses: Building uses, including commercial uses and community facilities, that engage the general public and encourage pedestrian traffic at all times of day. Residential and office units are considered passive at-grade uses.

Animation: The built environment can support sustained activity through choice of material and architectural details, visual and physical accessibility to interior activities, and the inclusion of supportive public facilities and amenities.

Articulation: The layout or pattern of building elements, including walls, doors, roofs, windows and decorative elements, such as cornices and belt-courses.

The addition of the effect of each of these elements forms the appearance of the building and, ultimately, the language used to communicate with its users and passerbys.

Blank Wall: Facades made up a single material, lack fenestration and that extend over 20 metres or the entire length of the building. Blank walls facing pathways and public spaces should be avoided.

Bollards: Low columns used to block vehicular traffic in an area; retractable bollards permit exceptional access to servicing and emergency vehicles.

Boulevard: The portion of land between the curb face and the property line, and usually includes the sidewalk.

Buffer: A strip of land, typically a landscaped area, that provides separation between land uses.

Building Envelope: The volume of space that may be occupied by a building, defined by a series of dimensional requirements such as maximum lot coverage, setback, stepback, and minimum/maximum height.

Built Form: The collective shape of a development, including buildings and other structures. It also refers to how buildings relate in terms of height, scale, and character.

Built Form Transition: The tapering of building heights as a way of achieving compatibility of built forms from areas of one character to another (eg: low rise to high rise).

Circulation: Movement patterns of pedestrians, vehicular and active transportation traffic.

Compatibility: Characteristics of differing scale, height, materials, fencing, and landscaping that are in harmony with one another.

Density: The total floor space of a building, or buildings, in relation to a given area of land.

Enclosure: The use of buildings, trees and street width to create a sense of defined space and shelter for pedestrians.

Facades: The exterior wall of a building that faces public view, usually referring to the front wall.

Fenestration: The arrangement of windows on a building.

Gateway: Gateways are locations in which a significant number of people enter and exit, usually places where a new character or sense of identity should be recognized. They occur at a variety of scales, including the neighbourhood as a whole, precincts, or specific streets or open spaces. The intent to symbolize an arrival to a distinct area can be achieved through details of the built form, or through landscaping and signage.

Human Scale: The impression of a building when seen in relation to its surroundings, or the size and proportion of parts of a building or its details, that relates in a positive way to the visual and physical experience of a pedestrian.

Landmark: A building, structure or space that is highly distinctive relative to its surrounding environment by virtue of height, size or some other aspect of design, and that provide a sense of location within the neighbourhood.

Large Site: Sites defined as “large” have a significant development area and the potential to impact the character of the surrounding areas. These larger sites typically include a full block, a mix of uses, multiple site consolidations, and infill projects. Interfaces with natural or cultural heritage on these sites should be identified in the context plan that is submitted with the Urban Design Brief.

LEED Certification: Leadership in Energy and Environmental Design (LEED) is an independent, third-party measurement standard which rates new buildings based on the level of energy use and environmental consideration.

L.I.D. Measures: L.I.D. is an approach to land development that works with nature to manage stormwater as close to its source as possible, and can be applied to new development, redevelopment, or as retrofits to existing development. L.I.D. principles include preserving and recreating natural landscape features and minimizing imperviousness on sites. Bioretention facilities, rain gardens, and permeable pavements are examples of how the principles are applied on site.

Massing: The combined effect of the height, bulk, and silhouette of a building or group of buildings.

Microclimate: Outdoor conditions around the building environment and the impact of buildings on site conditions, pedestrian spaces and adjacent buildings. Access to sunlight, wind levels and snow loads are influenced by placement, height, design, orientation and massing of new buildings.

Mid-Rise: Mid-Rise buildings are buildings between six and twelve storeys in height. These buildings help provide access to sunlight for pedestrians and trees at the street level, and the density of Mid-Rise neighbourhoods help support small retail, active transportation and active public spaces.

Mixed-Use: A mix of uses within a building, site, or area that can include employment, residential, commercial, live/work, and retail.

Node: A place where activity, transit, and routes are concentrated. Often used synonymously with junction.

On-Street Parking: Parking that lines the side of a street, usually with parallel or angled orientation.

Open Space: Land uses that “support passive recreational uses and ecological functions, such as trails, sensitive wetlands, valley lands and forests, cemeteries, the Don and Humber river systems, the casually tended landscapes around stormwater management ponds and greenways.” (VOP 7.3)

Park: Land uses that “support active and passive recreation and include playing fields, playgrounds, large and small event spaces, community spaces, aquatic facilities, field houses, skateboard parks and a variety of other uses across a hierarchy of park types, from large Regional Parks to smaller Urban Parks and Public Squares.” (VOP 7.3)

Performance Standard: A design standard that provides a clear and common set of expectations about how buildings, site plans and landscapes should be developed. Each performance standard recommends the key elements that are needed to achieve a certain objective. It is, however, not necessary to complete each element of a performance standard in order to fulfill an objective.

Permeability: The degree to which people in an area have access to a variety of pleasant, convenient and safe routes. Of materials: the porous quality of a surface that allows the entry of liquids.

Placemaking: Placemaking is an idea as well as a hands-on approach for improving a neighbourhood or region. With community-based support at its centre, placemaking capitalizes on a community’s assets, taking into account a place’s physical, cultural and social identities, to create quality public spaces for people.

Podium: Podiums are the lower portion or base of a building that defines the street edge or public realm, typically between three to six storeys in height.

The podium is the interface of the building as a whole with its context; the right definition of its massing, scale and materiality will determine the quality of the pedestrian experience.

Public Realm: Public and semi-public spaces in a city, including the spaces from building face to the opposite building face (including its facade, sidewalk and streets) and open spaces such as parks.

Right-of-Way: A strip of land used by pedestrians, vehicles, or utilities, including the space above and below the surface. Traditionally, this would include vehicular and bicycle circulation, a curb, and a boulevard with sidewalks for pedestrian circulation and a planting or spillover zone.

Rhythm: Design elements that occur at regular intervals to help structure their visual character and definition.

Scale: The scale of a building is its relative size as perceived and comprehended by pedestrians. It is a product of the combination of multiple factors including size, height, bulk, massing, materiality and context.

Setback: The minimum distance from the property line that a building must be built.

Small Convenience Parking: Short-term parking areas that are provided for office or commercial uses. Small convenience parking may be located at or in front of the primary building facade. It should not take up a width of more than 50% of the width of the building or be more than one aisle of parking in depth.

Stepback: A recess at the top of a building podium, base, middle, or upper that ensures an appropriate built form scale along the street edge and reduces the perception of mass in a building's upper levels.

Street Frontage: The part of the facade experienced at-grade. Active uses, such as retail, amenity areas, lobbies or front yards, should have an open and public presence to provide engaging ground level conditions.

Street Frontages characterized by blank facades, fences, enclosed gardens or garages result in inactive ground level conditions.

Streetwall: The streetwall is the condition of enclosure along a street created by the fronts of buildings, and enhanced by the continuity and height of the lower facades. Upper levels, when set back, have less impact on the streetwall.

A consistent streetwall to maintains a comfortable, pedestrian-scale enclosure in proportion to the right-of-way width.

Streetscape: The distinguishing elements of a street, created by its width, materials, street furniture, pedestrian amenities and the setback and form of surrounding buildings.

Tower: The upper portion of a high-rise buildings. Towers should be spaced 30 metres apart, and the maximum floorplate should not exceed 850 m² for residential buildings. High-Rise buildings are sometimes colloquially referred to as towers, e.g. the KPMG Tower in the Vaughan Metropolitan Centre.

Transit-Oriented Development: A transit-oriented development is a mixed-use residential and commercial area designed to maximize access to public transport and active transportation, to create a compact, complete community and to support safety and accessibility. As such, development is planned to accommodate compact typologies and often incorporates features to encourage these modes of transportation.

Transparency: The degree of visibility from the public realm into the private realm through a building's facade.

Tree Canopy: The area of a site occupied by the vertical projections of trees, including their trunks, branches and leaves.

Vegetative Buffer: A naturalized zone that provides an ecosystem transition between two land uses. A vegetative buffer may provide a transition from natural heritage and can also be used to provide some visual buffering between uses.

View Corridors: Buildings, roads and pedestrian connections shall be designed and located to maintain and enhance views within the district and to important features such as parks, open space areas, public art and gateways. These views should be framed with landscape and buildings.

Visual Buffer: Screening that provides privacy or shields unattractive land uses from view in the public realm. Visual buffers will often use solid materials, but can sometimes be vegetative.

Walkable: A street condition that is safe, barrier free, interesting, well-lit, comfortable and inviting for pedestrians.